



Pasaje José Melo N43-26 y Tomás de Berlanga.  
Quito / Ecuador



+593 2 264602 / 4604

M720LPFSOLSF\_CAT\_ENB02I

# LANPRO



## Fiber Solutions Catalog

[www.lanpro.com](http://www.lanpro.com)



# **LANPRO**

Fiber Solutions Catalog

# • CONTENT

<b>Cabling infrastructure: Copper vs Fiber?</b>	4
<b>LANPRO CABLES.</b>	
Indoor Cables	5
Outdoor Cables	7
<b>Fiber Optic Cable Types</b>	20
<b>FIBER PATCH CORD</b>	
Pigtal, Simplex & Duplex	24
LC Uniboot Patch Cord	25
Standard LC Patch Cord + Short Boot	26
LC + Bendable Boot	27
<b>Fiber Sizes &amp; Types</b>	30
Mini Breakout cable	31
Breakout cable	34
Array cable	37
Trunk cable	40
Direct Harness	43
Harness	45
Trunk Harness	47
40G to 100G Migration series MTP® & MPO Y cable	50
<b>What is MTP®, MPO?</b>	53
<b>FIBER CONNECTOR &amp; ADAPTOR</b>	
ST Type	55
FC Type	56
SC Type	58
LC Type	59
MTRJ Type	62
MTP® / MPO Type	63
HYBRID Adaptor	65
iMC® Series	66
<b>What is Fiber Optic Insertion Loss?</b>	68
Fusion Less	69
<b>PLUG &amp; PLAY</b>	71

<b>OPTICAL DISTRIBUTION FRAMES (ODF), WALL ENCLOSURES AND PATCH PANELS</b>	
12 Port, Optical Distribution Frame (ODF). Unloaded	78
24 Port, Optical Distribution Frame (ODF). Loaded	79
36 Port, Optical Distribution Frame (ODF). Loaded	80
48 Port, Optical Distribution Frame (ODF). Loaded	81
12 or 24 Port, Wall Mounted Optical Distribution Frame (ODF). Unloaded	82
36 or 48 Port, Wall Mounted Optical Distribution Frame (ODF). Unloaded	83
Adaptor Panel Loaded (for Classic Style ODF)	85
Adaptor Panel Unloaded (for Classic Style ODF)	86
Fiber Enclosure UniFiber™	89
Adaptor Panel Loaded (for UniFiber™ ODF)	91
<b>OPTICAL DISTRIBUTION FRAMES (ODF) FOR MTP®/MPO CASSETTES.</b>	<b>93</b>
MTP®/MPO Cassette	95
Ultra Slim Fiber Enclosure Series 96 & 144 port	101
Plastic Fiber Enclosures (FTTH) 2, 4 or 8 and 12 Ports, Plastic Fiber Enclosures (FTTH)	104
Universal Fiber Enclosure	106
Fiber Distribution Cabinets	108
<b><i>Fiber Optic Cable Colors. Realities and Myths</i></b>	<b>109</b>
<b>ACCESSORIES</b>	
Heat-shrinkable Single Fiber Fusion Splice Protection Sleeve	112
Heat-shrinkable accessory	114
Fan-Out Kits for Indoor use	115
<b><i>How to select the proper type of Optical Fiber?</i></b>	<b>118</b>
<b>FIBER BLOWING MACHINES</b>	
HDPE Tube Bundle DB Series	122
<b>RELATED PRODUCTS</b>	
Media Converters	127
Transceivers	128





**LanPro has consolidated itself with a broad Portfolio of products under the concept of ONE STOP SOURCE (OSS) philosophy, and is becoming one of the most demanded brands by System Integrators.**

**LanPro produces and distributes a broad line of Fiber Optic Products that as a whole constitute the LanPro Fiber Solution.**

**It has been split in two major areas: First, our Optical Cables per se, and second our line of Fiber Optic System, which includes the paraphernalia of Connectors, Patch Cords and Pigtails, Adaptors, Termination / Patch Panels and Accessories.**

**LanPro is committed to continue improving and enhancing its broad line of products in its LanPro Fiber Solution so that our clients can enjoy the benefits of the application of proven technologies in the Optical Fiber systems of today and Tomorrow.**

**LANPRO**

# Cabling infrastructure: Copper vs Fiber?



There is a variety of criteria to make choices.

## For Fiber:

---

- Fiber systems support greater bandwidth and error-free transmission over longer distances.
- Fiber systems are easier to test, saving time and money.
- Fiber is immune to EMI/RFI.
- Fiber system maximizes valuable space and its small size and weight require less space in cable trays, raised floors and equipment racks.
- IEE proposed Ethernet speed will be for 40Gbps and 100Gbps only over fiber.

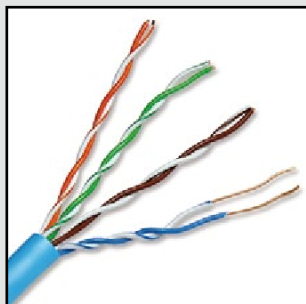

## For Copper:

---

- Low initial cost: The enterprise 10 Gigabit fiber electronics still remain costly compared to copper. The initial cost of 10 Gigabit copper systems, is projected at 40 percent of 10 Gigabit fiber products.
- 10 Gigabit Ethernet technology continues to evolve and improve. The networked enterprise switches, video servers, blade servers and other applications can benefit from 10 Gigabit speeds in storage, system backup, surveillance and teleconferencing. In this case, copper is still able to deliver high data rate.
- Copper cabling remains the preferred choice for the final link to desktop, and other short links such as those found in data centers.

# • LANPRO CABLES

LanPro has partnered with several fiber manufacturers in the development of Optical Cables that are suited for the myriad of applications in the field. Optical Cables are composed of two main parts: the Optical Fiber cores, bought from widely recognized manufacturers and the Jackets that are designed to protect those cores and suit them for the application.

We have selected the best fiber cores for our Optical Cables. We have included Corning® optical fiber as a first option. LanPro can use other brands as the core fibers as per our client specifications when production quantities meet the business objectives.

## Indoor Cables

### Tight Buffer

#### LP-OC31XX

Tight Buffer Distribution Fiber Optical Cable, LSZH rated jacket with FRP Central Strength Member and peripheral Aramid® strength fibers, Dry water block and Ripcord.

##### Performance:

- High quality Corning® Cores for World Class Performance.
- **LANPROFLEX™** Outstanding flexibility and handling.
- Zero Halogen LSZH jacket, flame retardant for protection of people when taking fire.
- Lightweight, all dielectric self supporting (ADSS) construction is ideal for use near electrical power lines.

##### Convenience:

- Usable in indoor cabling or for Inter-building voice or data communication backbones.
- Installable in ducts, underground conduit or aerial/lashed and as connecting soft cable along walls, ceiling, layers and tubes.
- High visibility bright yellow jacket for easier identification in bundles.

##### Mechanical:

- The strength members, made of Fiber Reinforced plastic (FRP) and Aramid® yarn, ensures tension resistance and long-term stability in transmission and superior fiber protection.
- Good mechanical and temperature performance.
- Good crush resistance and dry water blocking.
- Tight buffer provides individual fiber protection

##### Ease of termination:

- Very easy to strip and terminate.
- Aramid strength members reinforce and protect the fibers and reduce weight for longer span lengths.
- Tight buffered fibers are easy to handle and strip for field termination.

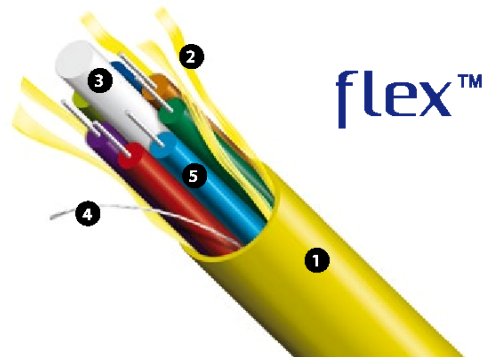
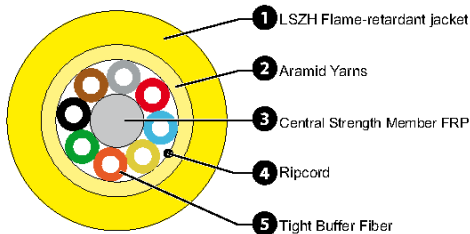

## Tight Buffer

### LP-OC25XX

**Tight Buffer Distribution Fiber Optical Cable, PVC jacket, Dry Water Block Cable Core, Multi-Fiber Aramid® yarns for strength.**

- Aramid Yarn-filled construction for superior fiber protection.
- Lightweight, flexible design simplifies installation.
- Tight buffer provides individual fiber protection.
- Tight buffered fibers are easy to handle and strip for field connectorization.
- Good mechanical and temperature performance.

- Good crush resistance water blocking and flexibility.
- Aramid strength members reduce weight for longer span lengths.
- Lightweight, all dielectric self supporting (ADSS) construction is ideal for use near electrical power lines.

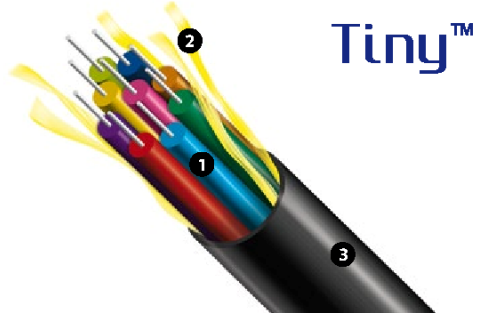
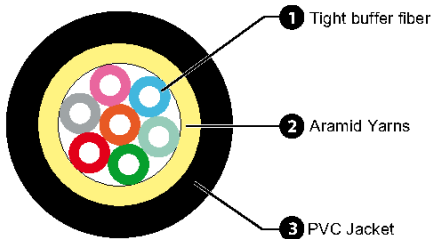

## Indoor FTTH (Fiber to the home)

### LP-OC32XX

**All dielectric Drop Fiber Optical Cable with Colored Coating Fibers, LSZH Jacket, Two Strength members FRP, Bow Type, FTTH (Fiber to the home) and 1, 2, 4, or 6 singlemode or multimode fiber cores.**

- Special low-bend-sensitivity fiber provides high bandwidth and excellent communication transmission property.
- Two parallel FRP strength members ensure good performance of crush resistance to protect the fiber.
- Simple structure, lightweight, high tensile strength and Novel groove design, easily strip and splice for simplified installation and maintenance.

- Low smoke, zero halogen and flame retardant sheath, environmental-friendly, and with excellent safety characteristics for Indoor use.
- Colored coated cores.

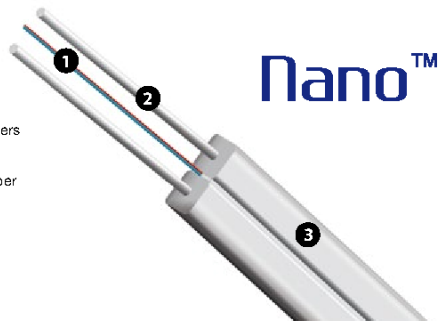
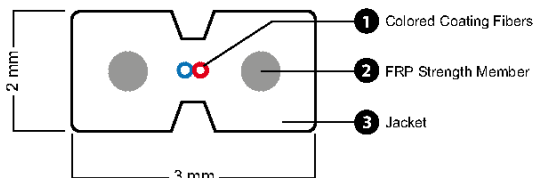

## ADSS Light ADSS (Short span, up to 75m)

### LP-OC51XX

All dielectric self supporting Fiber Optical Cable for up to 75m span with Loose Tubes and Single PE Jacket, with Central Strength Member FRP, Peripheral Aramid® Yarns, Dry Water Blocking Tape and Ripcord.

- 4-144 Fibers.
- Dielectric Construction.
- Outdoor usage.
- Single PE Jacket.
- Aramid® Yarns for Protection.
- FRP Strength Member.
- Loose tube gel filled construction for superior fiber protection.
- UV- and moisture-resistant design.
- Dry Water Block tape with ripcord.
- Up to 75 m free span.

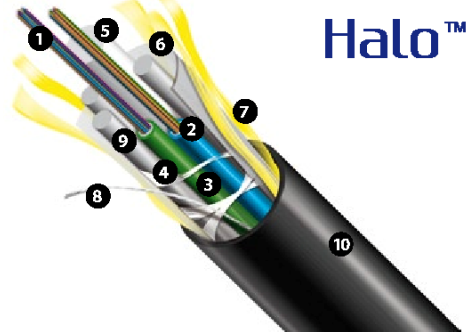
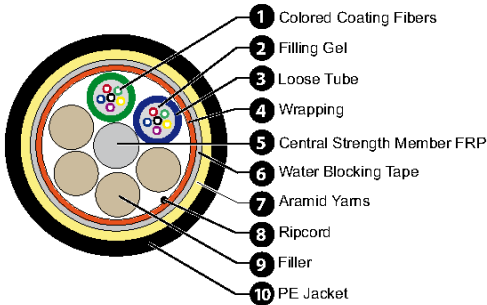

Halo™

### LP-OC05XX

All dielectric self supporting Fiber Optical Cable for up to 75m span with Loose Tubes and single PE jacket, central strength member FRP, Peripheral Aramid® yarns, Gel Water Blocking Cable core and ripcord.

- Loose tube gel-filled construction for superior fiber protection.
- UV- and moisture-resistant design.
- Gel Water Block cable core for better water blocking.
- Central strength member made of fiber reinforced plastic (FRP).
- Fully dielectric construction for use in high voltage installations.
- With Aramid® fiber peripheral reinforcement.

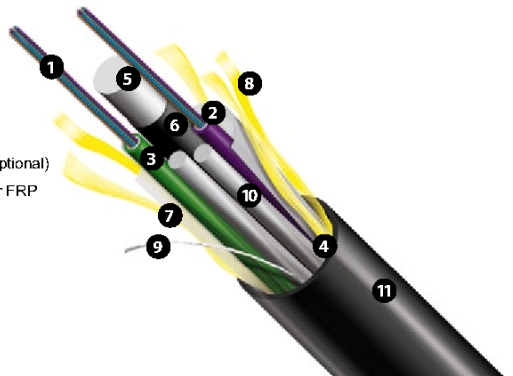
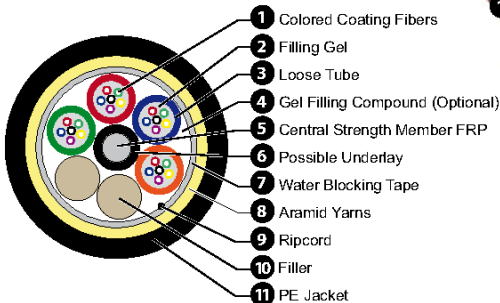

## ADSS Medium ADSS (Medium span, from 75m to 150m span)

### LP-OC62XX

All dielectric self supporting Fiber Optical Cable for selectable spans from 75m to 150m, with Loose Tubes, Single PE Jacket, Central Strength member FRP, Peripheral Aramid® Yarns, Water Blocking Yarns, Tape, Gel and Ripcord.

- All Dielectric Self Supporting Optical Cable for selectable Spans from 75m to 150m.
- Subscriber Network Systems.
- Local Area Network Systems.

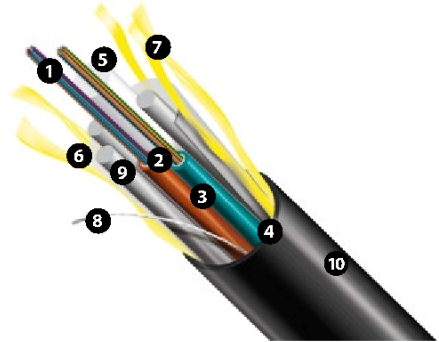
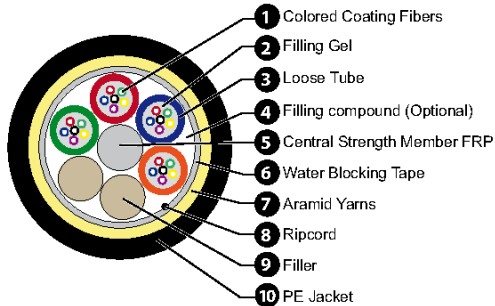

## ADSS Heavy Duty ADSS (Long span, greater than 150m)

### LP-OC10XX

All dielectric self supporting Fiber Optical Cable for long span greater than 150m, with Loose Tubes, Double PE Jacket, Central Strength member FRP, peripheral Aramid® Yarns and Ripcord.

- Loose tube gel filled construction for superior fiber protection.
- UV- and moisture-resistant design.
- Rodent-resistant construction.
- Dry Water Block cable core for ease of handling.
- Over 150 m span.
- For distances greater than 150m.

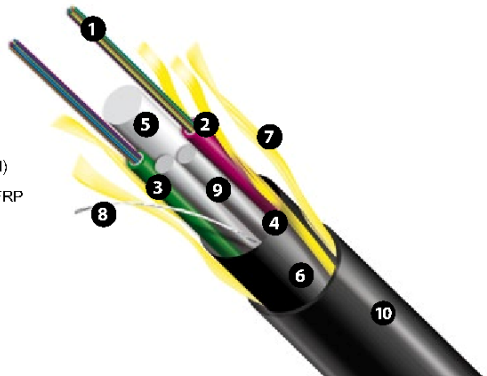
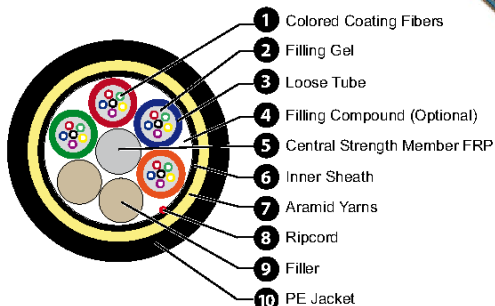

## Armored Cables Light Armored

### LP-OC52XX

Fiber Optical Cable with Loose Tubes, Single PE Jacket, Corrugated steel tape, Central Strength Member FRP, Dry Water Blocking tape and Ripcord.

- Interbuilding voice or data communication backbones.
- Campus Lan, (CAN). Designed for rough conditions.
- Outdoor applications.
- Usable lashed Aerial, ducted or direct burial.
- Junction type Communication Systems.
- Subscriber network systems.
- Local area network systems.
- Usable on long-haul applications.

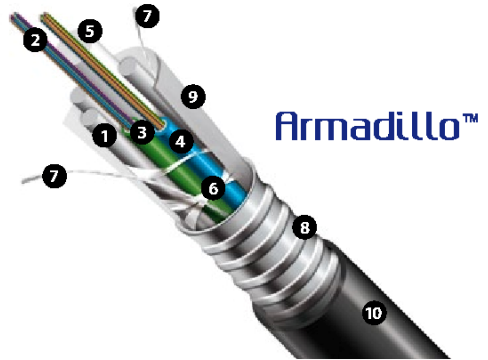
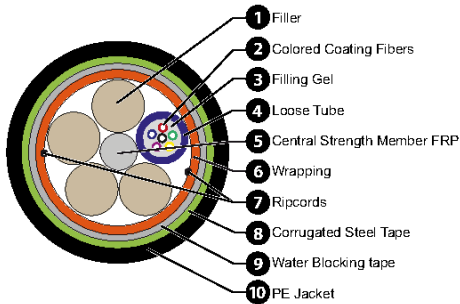

### LP-OC15XX

Fiber Optical Cable with Loose Tubes, Single PE Jacket, Steel wire Stranded Core central strength member, Dry Water Block Cable Core and Ripcord.

- Loose tube gel filled construction for superior fiber protection.
- UV- and moisture-resistant design.
- Dry Water Block cable core for ease of handling.
- Peripheral strenght is provided by the aluminium tape.
- Strenght member of stranded steel wires.

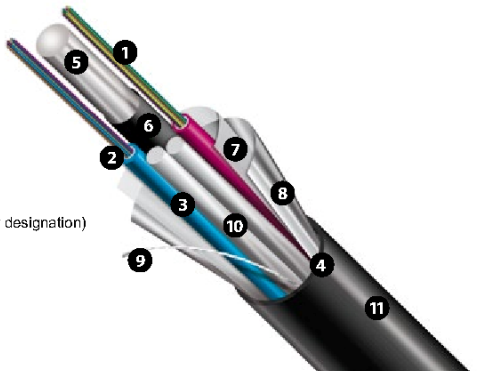
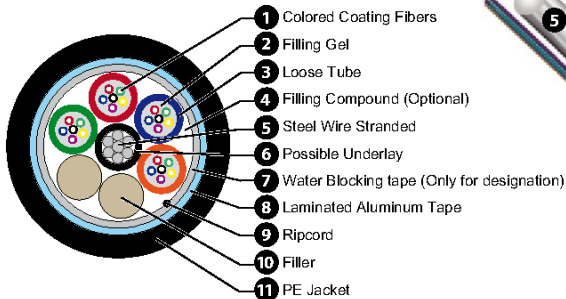



## Armored Cables Light Armored

### LP-OC47XX

Fiber Optical Cable with Loose Tubes, Single PE Jacket, Central Strength member FRP, Laminated Aluminum tape and Ripcord.

- Loose tube gel filled construction for superior fiber protection.
- UV- and moisture-resistant design.

- Laminated Aluminum Tape.
- Dry Water Block cable core for ease of handling.

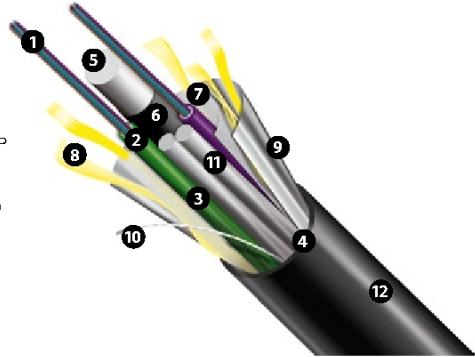
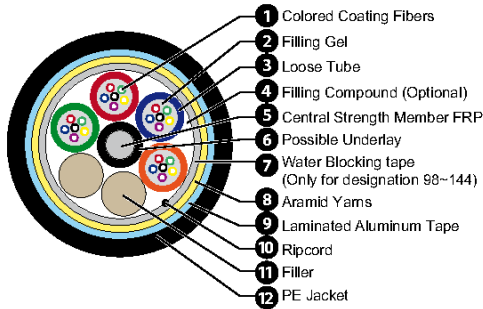

### LP-OC08XX

Fiber Optical Cable with Loose Tubes, Single PE Jacket, self supporting, Figure 8, Central steel wire, messenger wire, Laminated Aluminum tape and Ripcord.

- Loose tube gel filled construction for superior fiber protection.
- UV- and moisture-resistant design.

- Rodent-resistant construction.
- Dry Water Block cable core for ease of handling.

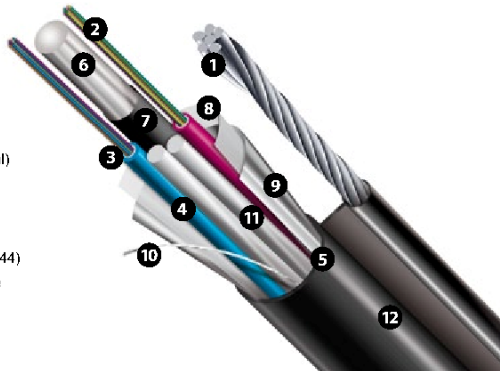
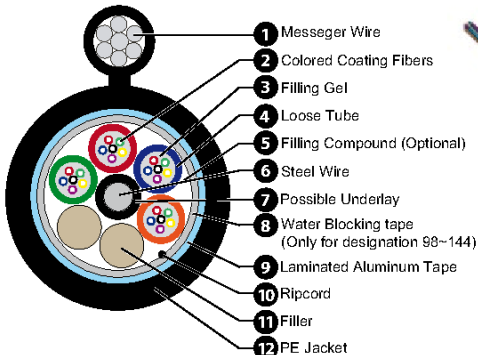



## Armored Cables | Light Armored

### LP-OC16XX

Fiber Optical Cable with Loose Tubes, Single PE Jacket, Central Steel wire/Stranded Core Strength Member, Dry Water Block Cable Core, Corrugated Steel Tape and Ripcord.

- Loose tube gel filled construction for superior fiber protection.
- UV- and moisture-resistant design.

- Dry Water Block cable core for ease of handling.
- Heavy Duty corrugated steel tape.

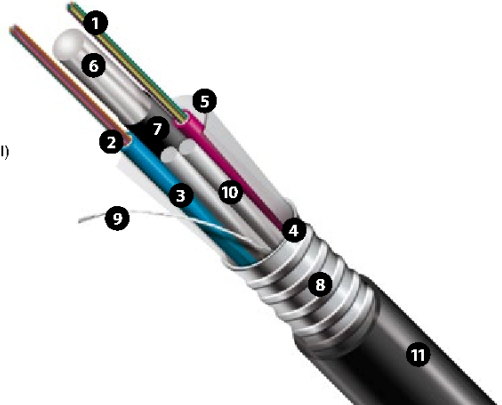
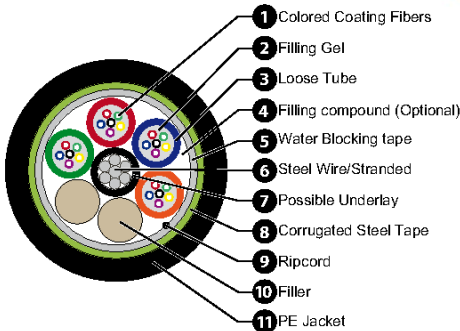

### LP-OC17XX

Fiber Optical Cable with Loose Tubes, Single PE Jacket, Central Strength member FRP, Dry Water Block Cable Core, with corrugated steel tape and Ripcord.

- Loose tube gel filled construction for superior fiber protection.
- UV- and moisture-resistant design.

- Corrugated Steel Tape.
- Dry Water Block cable core for ease of handling.

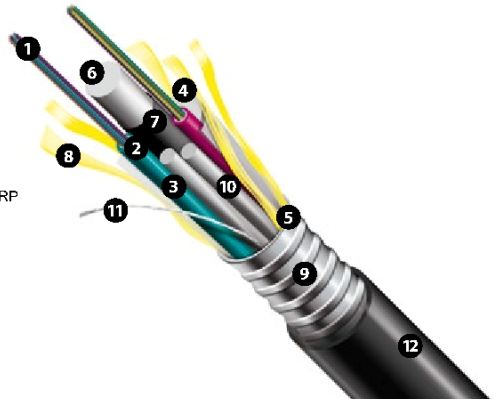
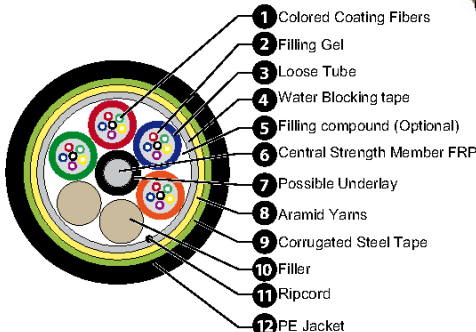

## Armored Cables Light Armored

### LP-OC50XX

Fiber Optical Cable with Loose Tubes, Single PE Jacket, Central Strength member FRP, Corrugated steel tape, Peripheral Aramid® yarns, Dry Water Blocking tape and Ripcord.

- Interbuilding voice or data communication backbones.
- Campus Lan, (CAN).
- Designed for rough conditions.
- Outdoor applications.
- Usable lashed Aerial, ducted or direct burial.
- Junction type Communication Systems.
- Subscriber network systems.
- Local area network systems.
- Usable on long-haul applications.

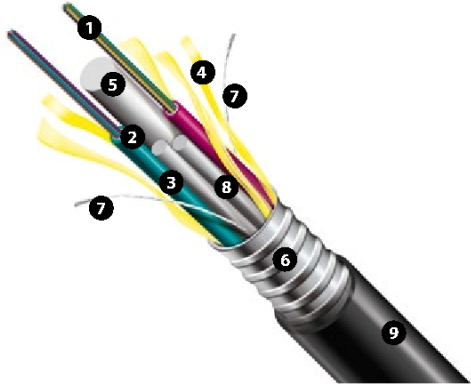
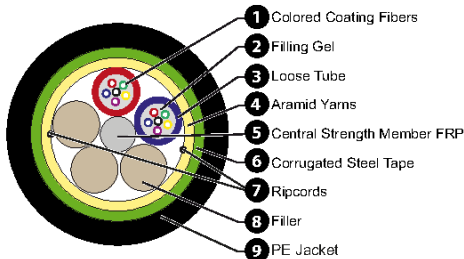

### LP-OC20XX

Fiber Optical Cable with Loose tube, Single PE Jacket, armored with two steel wires strength members, laminated steel tape, Dry Water Blocking tape and Ripcord.

- Loose tube gel-filled construction for superior fiber protection.
- UV- and moisture-resistant design.
- Rodent-resistant construction.
- Dry Water Block cable core for ease of handling.

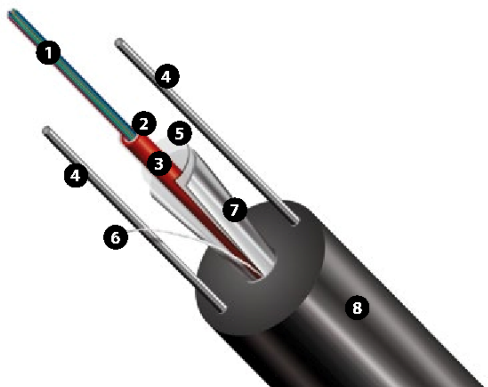
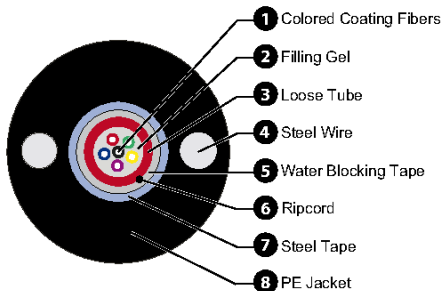

## Armored Cables | Light Armored

### LP-OC21XX

Fiber Optical Cable with central Loose Tube, Single PE Jacket, layer of galvanized steel wires strength member, and Ripcord.

- Loose tube gel-filled construction for superior fiber protection.

- UV- and moisture-resistant design.
- Dry Water Block cable core for ease of handling.

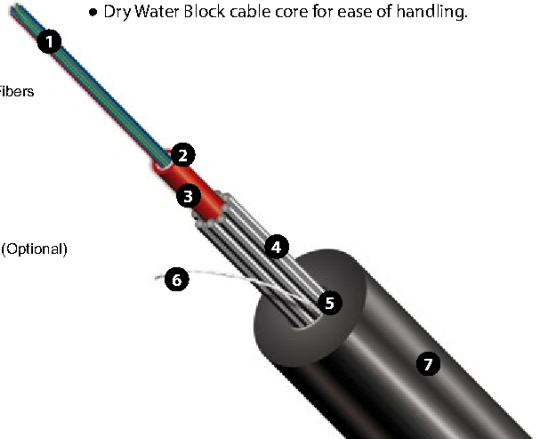
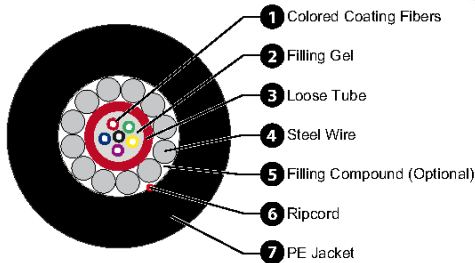

### LP-OC22XX

Fiber Optical Cable with central Loose Tube, Single PE Jacket, layer of galvanized steel wires strength member, bonded steel tape, water blocking tape and Ripcord.

- Loose tube gel filled construction for superior fiber protection.
- UV- and moisture-resistant design.

- Dry Water Block cable core for ease of handling.
- Waterproof Tape.

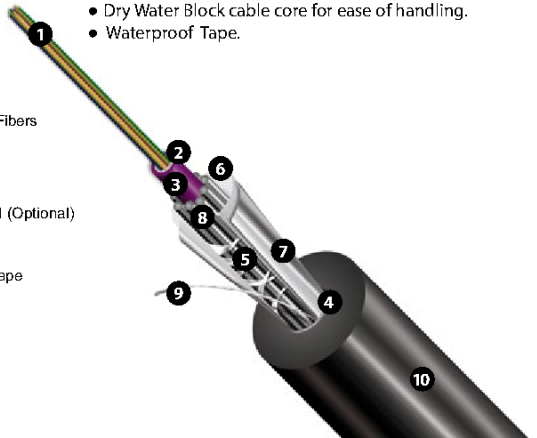
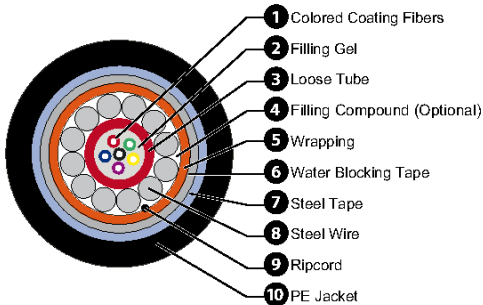

## Armored Cables Medium Armored

### LP-OC03XX

Fiber Optical Cable with Loose Tubes, Double PE Jacket, Central Strength member FRP, Corrugated Steel Tape, Dry Water Block Cable Core and Ripcord.

- Loose tube gel filled construction for superior fiber protection.
- UV- and moisture-resistant design.
- Rodent-resistant construction.

- Gel Water Block cable core for protection against moisture filling cavity between FRP strength member and inner PE sheath.

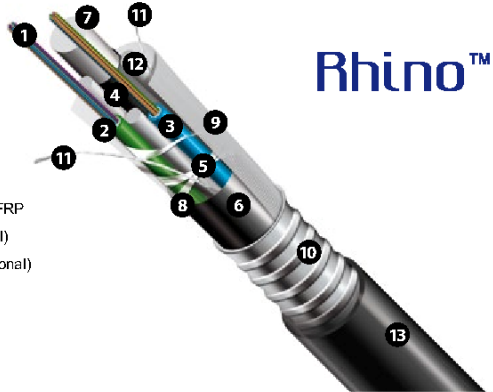
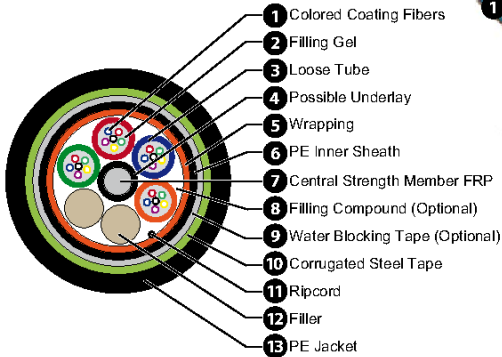

### LP-OC02XX

Fiber Optical Cable with Loose Tubes, Double PE jacket, Central Steel wire/Stranded Core, Corrugated Steel Tape, Dry Water Block Cable Core and Ripcord.

- Loose tube gel-filled construction for superior fiber protection.
- UV- and moisture-resistant design.

- Rodent-resistant construction.
- Dry Water Block cable core for ease of handling.

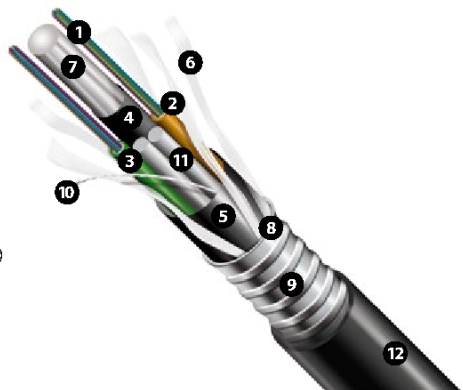
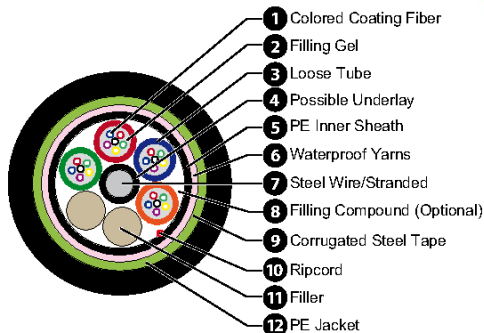

## Armored Cables Heavy Armored

### LP-OC18XX

Fiber Optical Cable with Loose Tubes, Double PE Jacket, Central Steel wire/Stranded Core, Laminated Aluminium Tape, and Ripcord.

- Loose tube gel-filled construction for superior fiber protection.
- UV- and moisture-resistant design.

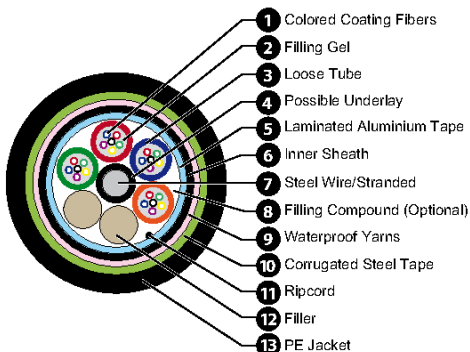

- Rodent-resistant construction.
- Dry Water Block cable core for ease of handling.

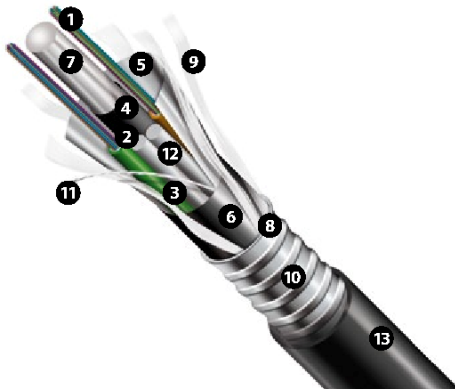

### LP-OC19XX

Fiber Optical Cable with Loose Tubes, Double PE Jacket, Central Strength member FRP, laminated aluminium tape, corrugated steel tape and Ripcord.

- Loose tube gel filled construction for superior fiber protection.
- UV- and moisture-resistant design.

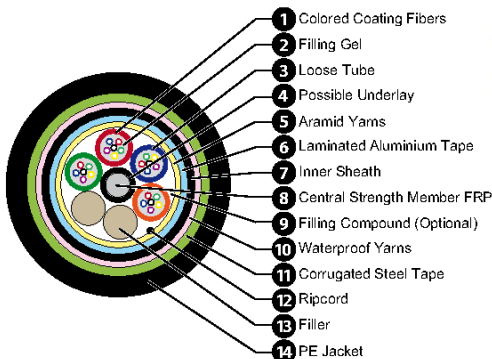

- Rodent-resistant construction.
- Dry Water Block cable core for ease of handling.

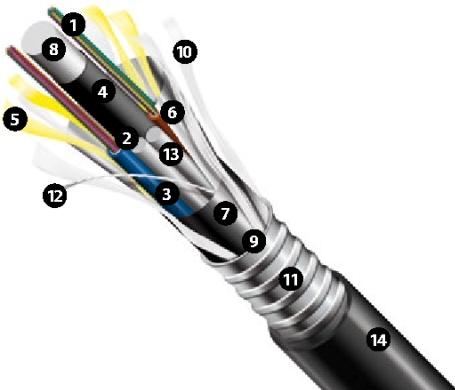

## Armored Cables Heavy Armored

### LP-OC07XX

Fiber Optical Cable with Loose Tubes, Double PE Jacket, self supporting, Figure 8, central steel wire, messenger wire, laminated aluminum tape for strength, Dry Water Block Cable Core and Ripcord.

- Loose tube gel-filled construction for superior fiber protection.
- UV- and moisture-resistant design.
- Rodent-resistant construction.
- Dry Water Block cable core for ease of handling.

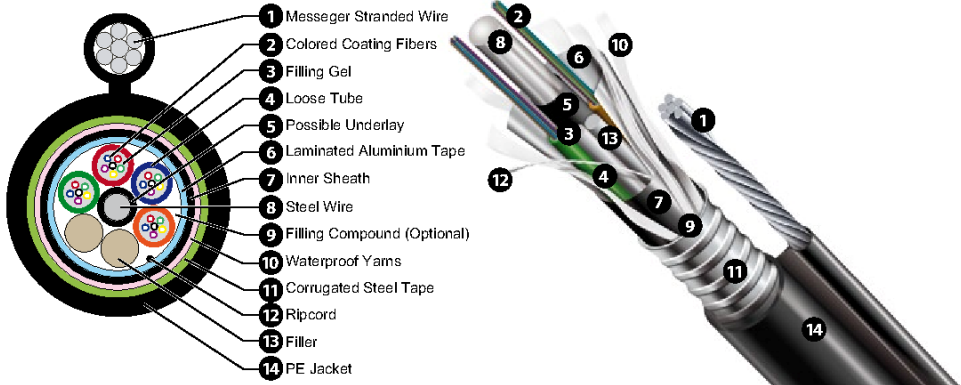

## Outdoor FTTH (Fiber to the home)

### LP-OC34XX

All dielectric Flat Drop Mini LT Fiber Optical Cable with Loose tube, Single PE Jacket, self supporting, Two Strength members FRP, and 4, 8 or 12 singlemode or multimode fiber cores.

- Special low-bend-sensitivity fiber provides high bandwidth and excellent communication transmission properties.
- Simple structure, light weight, high tensile strength.
- With four (4), eight (8) or twelve (12) Fibers.
- Two parallel FRP strength members ensure good performance of crush resistance to protect the fiber.

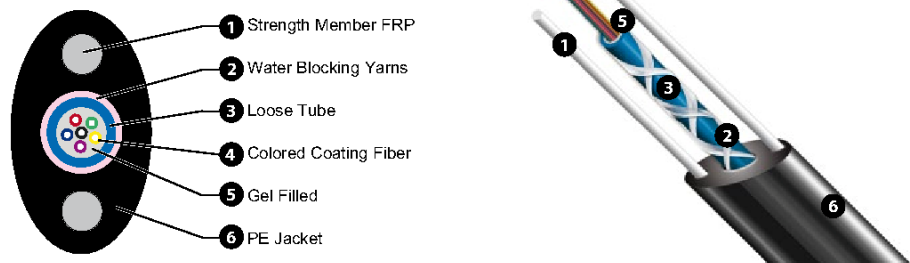

## Outdoor FTTH (Fiber to the home)

### LP-OC33XX

Dielectric Drop Fiber Optical Cable with Colored coating fibers, PE Jacket, self supporting, central steel wire, Bow type, Two Strength members FRP and 1,2,4,6 singlemode or multimode fiber cores.

- Special low-bend-sensitivity fiber provides high bandwidth and excellent communication transmission properties.
- Simple structure, light weight, high tensile strength.
- One (1), Two (2), Four (4) or Six (6) fiber cores.
- Two parallel FRP strength members ensure good performance of crush resistance to protect the fiber.
- A steel wire is added for self support enabling it to be used in outdoor aerial Fiber To The Home (FTTH) applications.
- Novel groove design, easily strip and splice, simplified installation and maintenance.

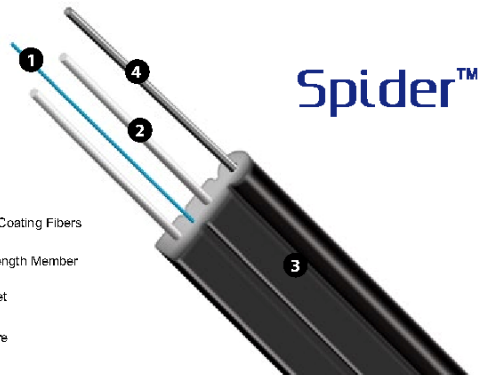
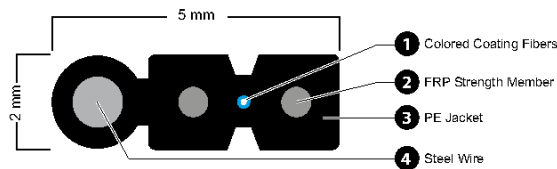

**Note:**  
*All our fiber optical cables can be designed and supplied under customer request*

# Order Information

**LP-OC 03 01 008 4 QL**

LP-OC	CABLE TYPE		
LANPRO FIBER CABLE	05	Loose Tube Single Jacket with FRP central strength member	Duct, Direct Buried or Aerial
	06	Loose Tube Single Jacket Armored.	20 Loose Tube Single Jacket Armored cable with Two steel wires strength member and Laminated Steel Tape.
	09	Loose Tube Single Jacket Ribbon Cable.	Aerial Self Supporting
	11	Toneable Flat Drop Cable.	07 Loose Tube Single Jacket Armored Self-Supporting Figure 8 with central steel wire, messenger wire and laminated aluminum tape for strength.
	13	Compact Central Loose Tube Drop Cable.	08 Type 08 (Loose Tube Single Jacket Self Supporting Figure 8 with central steel wire, messenger wire and laminated aluminum tape for strength.
	14	Central Tube Single Jacket Armored.	12 Mini (Figure 8) Drop Cable.
	15	Loose Tube Single Jacket with Steel Wire/Stranded Central Strength Member.	21 Loose Tube Single PE Jacket with Layer of Galvanized steel wires strength member.
	16	Loose Tube Single Jacket Light Armored Steel Wire/Stranded Central Strength Member.	53 Loose Tube Single Jacket Self Supporting Figure 8 with central steel wire, messenger wire and laminated steel tape for strength.
	17	Loose Tube Single Jacket Light Armored with FRP Central Strength Member and Laminated Aluminum Tape.	Aerial Outdoor
	40	Tight Buffer Distribution Riser Cable.	22 Loose Tube Single PE Jacket with bonded Steel Tape with Layer of Galvanized steel wires strength member and wrapping.
	41	Tight Buffer Distribution Plenum Cable.	33 Tight Buffer Outdoor Steel Self Supporting, Bow Type FTTH Drop Optical Cable LSZH Jacket (GJRFCH).
	42	Loose Tube Dual Jacket Armored LSZH.	34 Flat Drop Mini LT (Gel Filled Loose Tube) Fiber Cable Outdoor, Self supporting All Dielectric, With Water Blocking Aramid Yarns, Fiber To Premises aerial deployment.
	43	Loose Tube Double Jacket Riser-Chemical-Resistant.	Aerial for power line
	44	Loose Tube Single Jacket Plenum.	10 All Dielectric Self Supporting.
	45	Loose Tube Single Jacket Riser.	60 All Dielectric Self Supporting Optical Cable for 80 m Span Single Jacket.
	46	Loose Tube Single Jacket LSZH.	61 All Dielectric Self Supporting Optical Cable for 80 m Span Double Jacket.
	47	Loose Tube Single Jacket Indoor/Outdoor with laminated aluminum tape.	62 All Dielectric self supporting Optical Cable for 75m to 150m medium Span Single Jacket.
	48	Central Tube Single Jacket Plenum.	Indoor
	49	Spare.	25 Tight Buffer Distribution PVC Cable.
50	Outdoor/Indoor Loose Tube Single PE Jacket, Corrugated steel tape armored with FRP Central Strength Member and peripheral aramid yarns for strength.	26 Tight Buffer Breakout Plenum cable.	
51	Outdoor/Indoor Loose Tube Single PE Jacket, with FRP Central Strength Member and peripheral aramid yarns for strength.	27 Tight Buffer Breakout Riser cable.	
52	Outdoor/Indoor Loose Tube Single PE Jacket, Corrugated steel tape armored with FRP Central Strength Member with Dry Water Block tape with Rip Cord.	28 Tight Buffer Distribution Riser cable.	
Direct Buried		29 Tight Buffer Distribution Plenum.	
02	Loose Tube Dual Jacket Armored with central steel wire/stranded.	30 Tight Buffer Distribution LSZH.	
03	Loose Tube Dual Jacket Armored with FRP central strength member.	31 LANPROFLEX® Indoor Tight Buffer Distribution LSZH rated with FRP Central Strength Member and peripheral Aramid strength fibers.	
Direct Buried with armor.		32 Tight Buffer Indoor FRP Bow Type FTTH Drop Optical Cable LSZH Jacket.	
01	Loose Tube Triple Jacket Dual Armor.		
04	Loose Tube Dual Jacket Dual Armor.		
18	Loose Tube Single jacket Armored with Metallic Central Strength Member and Laminated Aluminum Tape.		
19	Loose Tube Single jacket Armored with FRP Central Strength Member and Laminated Aluminum Tape.		

## Example:

**LP-OC03010084QL** Fiber Optical Cable with Loose Tubes, Double PE Jacket, Central Strength member FRP, Corrugated Steel Tape, Dry Water Block Cable Core, 8 Fibers, Multimode 62.5/125 – IEC 60793-2-10 type A1B standard and Ripcord.



# Order Information

**LP-OC 03 01 008 4 QL**

JACKET SUFFIX		FIBER COUNT	BUFFER CONSTRUCTION		FIBER TYPE	
00	Black Jacket (UV Resistant).	001-144	1	Tight Buffer.	ZC	Full spectrum, low water peak singlemode, ITU-T G.652.D
01	Gel Water Block Cable Core.		2	Quick Strip.	ZB	Full spectrum, high performance low water peak singlemode with 0.35/0.25 attenuation, ITU-T G.652.D
02	Dry Tube.		3	Single Fiber Loose Tube (Gel Filled).	ZE	Full spectrum, low water peak singlemode with 900µm PVC buffer, ITU-T G.652.D
03	Interlock Armor Plenum Steel.		4	Multi-fiber Loose Tube (Gel- Filled).	ZG	Large Aeff, low water peak, NZ-DSF singlemode, ITU-T G.655
04	Interlock Armor Plenum Aluminum.		5	Loose Buffer.	ZA	Full spectrum with best macrobending performance, ITU-T G.657.A2/B2
05	Interlock Armor Plenum Steel w/Sub-Units.		6	Bare/Ribbon.	ZD	Full spectrum with best macrobending performance, ITU-T G.657.A1/B1
06	Interlock Armor Plenum Aluminum w/Sub-Units.		7	Colored Coating Fiber.	ZF	Full spectrum with best macrobending performance, ITU-T G.657.A1/B1
07	Interlock Armor Riser Steel.				QG	1 Gb/s < 300 m at 850 nm, OM1* 1 Gb/s < 550 m at 1300 nm
08	Interlock Armor Riser Aluminum.				QL	1 Gb/s < 500 m at 850 nm, OM1* 1 Gb/s < 1000 m at 1300 nm
09	Interlock Armor Riser Steel w/Sub-Units with Ripcord.				BI	10 Gb/s < 150 m at 850 nm, OM2* 1 Gb/s < 750 m at 850 nm
10	Interlock Armor Riser Aluminum w/Sub-Units with Ripcord.				TP	10 Gb/s < 300 m at 850 nm, OM3* 1 Gb/s < 1000 m at 850 nm
11	N.U.				TG	10 Gb/s < 550 m at 850 nm, OM4* 1 Gb/s < 1100 m at 850 nm
12	DRY Water Block Cable Core with ripcord.				TI	10 Gb/s < 600 m at 850 nm, OM4+* 1 Gb/s < 1100 m at 850 nm
13	DRY Water Block Cable Core.					
14	Black Jacket (UV Resistant).					

**Example:**

**LP-OC03010084QL** Fiber Optical Cable with Loose Tubes, Double PE Jacket, Central Strength member FRP, Corrugated Steel Tape, Dry Water Block Cable Core, 8 Fibers, Multimode 62.5/125 – IEC 60793-2-10 type A1B standard and Ripcord.

# Fiber Optic Cable Types

## Tight Buffer Cable Types

---

There are two basic types of cables, generally defined as tight buffer and loose tube. Tight buffer cables (simplex, zipcord, distribution and breakout) are used in premises applications where cable flexibility and ease of termination are important, more so than ruggedness and pulling strength which characterize loose tube and ribbon types of cable. Generally, tight buffer cables are used indoors and loose tube/ribbon cables outdoors.

## Distribution Cable

---

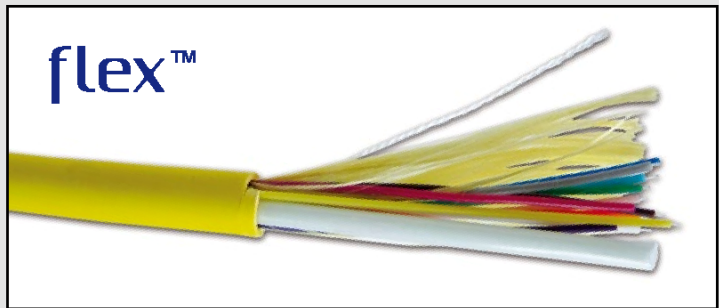

Distribution cable is the most popular indoor cable, as it is small in size and light in weight. They contain several tight-buffered fibers bundled under the same jacket with Kevlar strength members and sometimes fiberglass rod reinforcement to stiffen the cable and prevent kinking. These cables are small in size, and used for short, dry conduit runs, riser and plenum applications.

The fibers are double buffered and can be directly terminated but because their fibers are not individually reinforced, these cables need to be broken out with a “breakout box” or terminated inside a patch panel or junction box to protect individual fibers.

# Fiber Optic Cable Types

## Breakout Cable



Breakout cable is a favorite where rugged cables are desirable or direct termination without junction boxes, patch panels or other hardware is needed. They are made of several simplex cables bundled together inside a common jacket. This is a strong, rugged design, but is larger and more expensive than the distribution cables. It is suitable for conduit runs, riser and plenum applications. It's perfect for industrial applications where ruggedness is needed. Because each fiber is individually reinforced, this design allows for quick termination to connectors and does not require patch panels or boxes.

Breakout cable can be more economic where fiber count isn't too large and distances too long, because it requires so much less labor to terminate.

## Loose Tube Cable Types



Loose tube cables are the most widely used cables for outside plant trunks because it offers the best protection for the fibers under high pulling tensions and can be easily protected from moisture with water-blocking gel or tapes.

# Fiber Optic Cable Types

These cables are composed of several fibers together inside a small plastic tube, which are in turn wound around a central strength member; surrounded by aramid strength members and jacketed, providing a small, high fiber count cable. This type of cable is ideal for outside plant trunking applications, as it can be made with the loose tubes filled with gel or water absorbent powder to prevent harm to the fibers from water. It can be used in conduits, strung overhead or buried directly into the ground. Some outdoor cables may have double jackets with a metallic armor between them to protect from chewing by rodents or Kevlar for strength to allow pulling by the jackets. Since the fibers have only a thin buffer coating, they must be carefully handled and protected to prevent damage. Loose tube cables with singlemode fibers are generally terminated by splicing pigtails onto the fibers and protecting them in a splice closure. Multimode loose tube cables can be terminated directly by installing a breakout kit, also called a furcation or fan-out kit, which sleeves each fiber for protection.

## Armored Cable

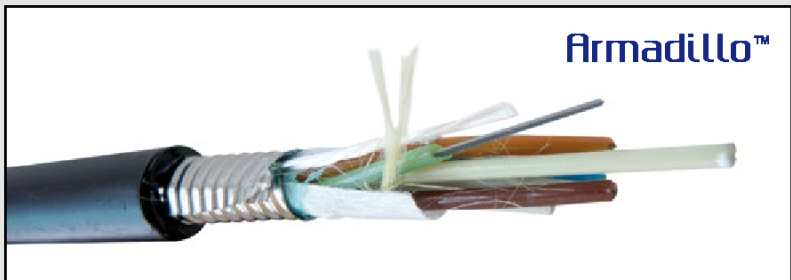

Armored cable is used in direct buried outside plant applications where a rugged cable is needed and/or for rodent resistance. Armored cable withstands crush loads well, needed for direct burial applications. Cable installed by direct burial in areas where rodents are a problem usually has metal armoring between two jackets to prevent rodent penetration. Another application for armored cable is in data centers, where cables are installed under the floor and one worries about the fiber cable being crushed. Indoor armored cables may have nonmetallic armor. Metallic armored cable is conductive, so it must be grounded properly.

# Fiber Optic Cable Types

## Aerial Cable

---

Aerial cables are for outside installation on poles. They can be lashed to a messenger or another cable (common in CATV) has metal or aramid strength members to make them self supporting or strength members capable of supporting the cable (all-dielectric self-supporting or ADSS cable.) The cable known as a figure 8 cable has a cable bonded to an insulated steel messenger for support. It must be grounded properly.

A widely used aerial cable is optical power ground wire (OPGW) which is a high voltage distribution cable with fiber in a metallic tube in the center of the wire. The fiber is not affected by the electrical fields and the utility installing it gets fibers for grid management and communications. This cable is usually installed on the top of high voltage towers but brought to ground level for splicing or termination.

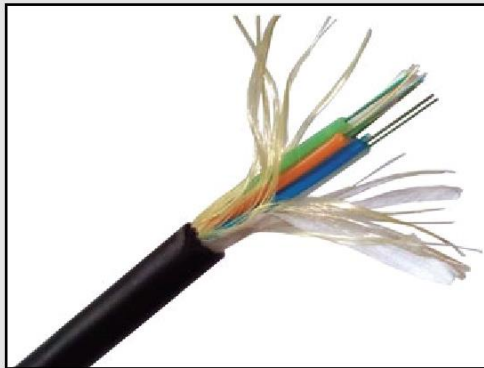

# • FIBER PATCH CORD

## Pigtail, Simplex & Duplex

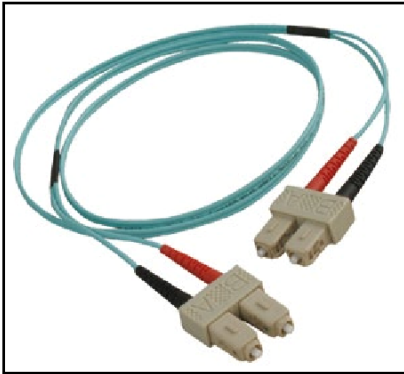

LanPro are manufactured strictly according to international standard. Pigtail is a fiber assembly that is 3 meters or less in length, having the connector termination on only one end of the fibers, and having the connector at only end of the cable assembly. For simplex or duplex patch cord, it means that a fiber assembly has one or two fibers, and with connectors at both end of each fiber. LanPro Pigtails are available in OS1/OS2, OM1, OM2, OM3 or OM4 and exceed requirements of TIA/EIA-568-C.3.

All LanPro SC and LC duplex fiber patch cords are provided with a flexible clip, which allows each connector to be removed individually and conduces to expedite troubleshooting an individual connector can be removed and re-terminated without perturbing the adjacent connector. All outer housing and connector body are color-coded in accordance with ANSI/TIA/EIA-568-C.3.

Additionally, LanPro supports LC patch cords with mSFP duplex clip (pitch: 5.25mm) and short mini boot (18.5mm), new strain relief boot.

These flexible features are to answer the requirements in Storage Area Networks (SAN) inside the data center on Brocade's new 64-port, 8-Gb/s Fiber Channel blade for the DCX switch frame. The 5.25mm reduces the typical pitch of LC and enables mating to the mSFP transceiver.

### Specifications:

ST, FC, SC, LC and MTRJ are available. PC, SPC, UPC and APC polish meet standard requirement

### Fiber Compatibility:

OM1, OM2, OM3, OM4, OS1/OS2

### Applications:

Provide interconnect and cross-connect of applications over installations in entrance facilities, telecommunications rooms, data centers and at desk.

OM1 (62.5/125um): for LED-based propagation  
OM2 (50/125um): for LED or VCSEL-based propagation  
OM3 & OM4 (150/125um): for VCSEL-based propagation  
OS1/OS2 (9/125um): Laser-based propagation.

The flexible clip allows each connector to be removed individually (this flexible-clip facility is available only for LC and SC duplex)

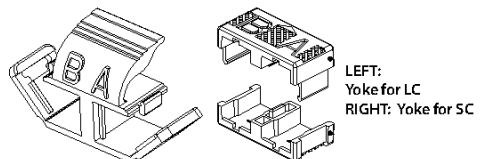
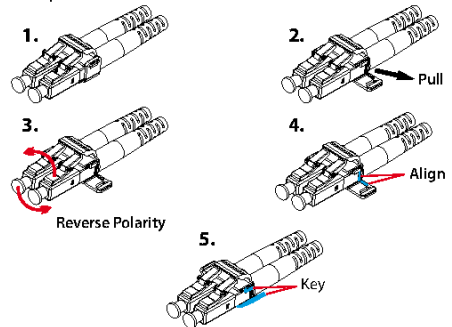

LEFT:  
Yoke for LC  
RIGHT: Yoke for SC

# LC Uniboot Patch Cord

LanPro LC uniboot series is integrated reverse-polarity uniboot duplex assembly that completely answers high-density requirements of the MDA and EDA. Compared with traditional duplex LC jumpers, uniboot series provides efficiently a 50-percent reduction in bulk cabling, including the improvement of cable management, air circulation and routing.

Incorporated with 3.0 mm dual an cable (containing 2 x 0.9 mm fiber), uniboot exclusively maximizes valuable space. The user regains control of the infrastructure rather than living with an unmanageable build-up of patch cords.

## Specifications:

Uniboot is only for LC, PC, SPC, UPC and APC polish meet standard requirement

## Fiber Compatibility:

OM1, OM2, OM3, OM4, OS1/OS2

## Applications:

Provide interconnect and cross-connect of applications over installations in entrance facilities, telecommunications rooms, data centers and at desk.

OM1 (62.5/125um): for LED-based propagation  
OM2 (50/125um): for or laser-based propagation  
OM3 & OM4 (50/125um): for VCSEL-based propagation  
OS1 & OS2 (9/125um): Laser-based propagation.

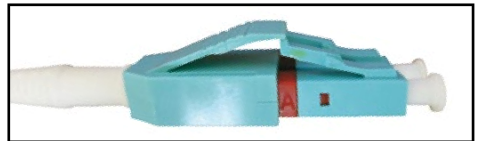
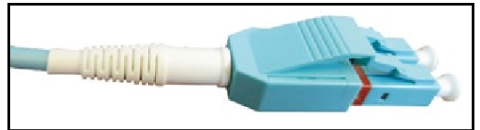

LanPro's LC Uniboot supports A & B identification on both edges.



Compared with the standard LC duplex patch cord, uniboot version increases high density efficiently

# Standard LC Patch Cord + Short Boot

LanPro LC short boot series is particularly for the high-density applications on account of the reduced overall connector length. LC connector is one compact version of optic fiber connectors. With short boot, length by 18.5mm, it absolutely meets the high-density requirements of the MDA and EDA.

## Specifications:

Short boot is for LC and 2.0mm cable only. PC, SPC, UPC and APC polish meet standard requirement.

## Fiber Compatibility:

OM1, OM2, OM3, OM4, OS1/OS2

## Applications:

Provide interconnect and cross-connect of applications over installations in entrance facilities, telecommunications rooms, data centers and at desk.

OM1 (62.5/125um): for LED-based propagation  
OM2 (50/125um): for or laser-based propagation  
OM3 & OM4 (50/125um): for VCSEL-based propagation  
OS1 & OS2 (9/125um): Laser-based propagation.



Right: standard LC boot Left: short LC boot (18.5mm).

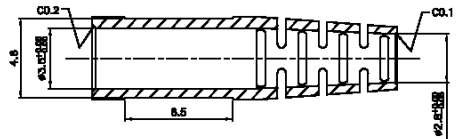
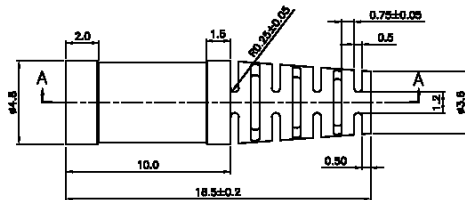



LanPro LC bendable boot series is designed to bend and maintain desired angle or direction. With a single stainless steel wire inside the boot, it is easy and convenient to be bended by hand, without any tool. Incorporated with ultra-bendable fiber cable, G657A1 and G657A2, this series maintains the stable performance and supports a minimum bend-radius of 10mm within minimal bend-induced attenuation loss. In data center, the network transmission increases rapidly, available margins tighten greatly and becomes sensitive to loss incorporated with a number factors. Bend is one of them. Attenuation loss, with neglecting bends, may be reduced 50% when using LC bendable series, it protects a system outage from severe bending problems. All outer housing and connector body are color-coded in accordance with ANSI/TIA/EIA-568-C.3

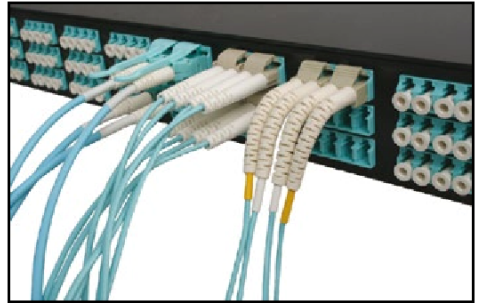

## Specifications:

LC is available. PC, SPC, UPC and APC polish meet standard requirement.

## Fiber Compatibility:

OM1, OM2, OM3, OM4, OS1/OS2

## Applications:

Provide interconnect and cross-connect of applications over installations in entrance facilities, telecommunications rooms, data centers and at desk

OM2 (50/125um): for LED or laser-based propagation  
OM3 & OM4 (50/125um): for VCSEL-based propagation  
OS1/OS2 (9/125um): Laser-based propagation.

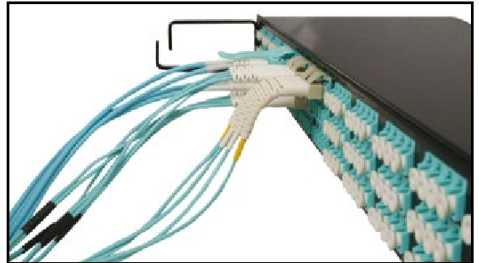

# Order Information

**LP-F XX T P O T P O CC J LLL B**

LP-F	FO PATCH CORD OR PIGTAILS	CONNECTOR TYPE FOR FIRST END	POLISH GRADE FOR FIRST END	OPTIONAL	CONNECTOR TYPE FOR SECOND END	POLISH GRADE FOR SECOND END	OPTIONAL					
LANPRO OPTIC FIBER	12	Simplex Optical Patch Cord/Pig Tail	0	None	0	None (pigtail)	-	0	None	0	None (pigtail)	-
	13	Duplex Optical Patch Cord (zipcord only)	T	ST Simplex	1	UPC polish, RL>50dB Blue Color Connector		T	ST Simplex	1	UPC polish, RL>50dB Blue Color Connector	
			G	FC Typical type Simplex disassembled	2	APC polish, RL>60dB Green Color Connector		G	FC Typical type Simplex disassembled	2	APC polish, RL>60dB Green Color Connector	
			D	Free	3	PC Polish, RL > 20dB Blue Color Connector		D	Free	3	PC Polish, RL > 20dB Blue Color Connector	
			E	E2000 Simplex	4	SPC polish, RL>40dB Blue Color Connector		E	E2000 Simplex	4	SPC polish, RL>40dB Blue Color Connector	
			K	E2000 Duplex				K	E2000 Duplex			
			5	Free				5	Free			
			6	Free				6	Free			
			F	FC Simplex				F	FC Simplex			
			S	SC Simplex				S	SC Simplex			
			C	SC Duplex				C	SC Duplex			
			J	Free				J	Free			
			P	LC Simplex				P	LC Simplex			
			L	LC Duplex				L	LC Duplex			
			7	Free				7	Free			
			8	Free				8	Free			
		M	MTRJ Female				M	MTRJ Female				
		N	MTRJ with Guide Pin Male				N	MTRJ with Guide Pin Male				
		Q	Free				Q	Free				

**Example:**

**LP-F13C30T3007P3M1** - Duplex Optical Patch Cord (Zipcord) SC Duplex Beige color connector / PC Polish, RL > 20dB to ST Simplex Beige color connector / PC Polish, RL > 20dB OM1 62.5/125um, 3.0mm, zipcord cable, orange jacket, PVC 3m length, Bendable boot.

# Order Information

**LP-F XX T P O T P O CC J LLL B**

CABLE TYPE		CABLE JACKET TYPE	LENGTH		BOOT TYPE	
01	Multimode OM1 62.5/125um, 3.0mm, simplex cable, orange jacket	P PVC Jacket	10m	Meter	Blank	Standard long boot
03	Multimode OM1 62.5/125um, 0.9mm, simplex cable, orange jacket	L LSZH Jacket			1	Bendable boot
04	Singlemode B1.3 9/125um, 3.0mm, simplex cable, Yellow jacket				2	Short boot
05	Singlemode B1.3 9/125um, 0.9mm, simplex cable, Yellow jacket					
06	Singlemode B1.3 9/125um, 0.9mm, simplex cable, White jacket					
07	Multimode OM1 62.5/125um, 3.0mm, zipcord cable, orange jacket					
08	Singlemode B1.3 9/125um, 3.0mm, zipcord cable, Yellow jacket					
09	Multimode OM2 50/125um, 3.0mm, simplex cable, orange jacket					
10	Multimode OM2 50/125um, 0.9mm, simplex cable, orange jacket					
11	Multimode OM1 62.5/125um, 0.9mm, simplex cable, White jacket					
12	Multimode OM1 62.5/125um, 2.0mm, simplex cable, orange jacket					
13	Multimode OM2 50/125um, 2.0mm, simplex cable, orange jacket					
14	Singlemode B1.3 9/125um, 2.0mm, simplex cable, Yellow jacket					
16	Multimode OM1 62.5/125um, 3.0mm, MTRJ dualan cable, orange jacket					
17	Singlemode G657 A1 9/125um, 0.9mm, simplex cable, Yellow jacket					
18	Multimode OM2 50/125um, 0.9mm, simplex cable, White jacket					
19	Singlemode G657 A1 9/125um, 0.9mm, simplex cable, White jacket					
20	Singlemode G657 A1 9/125um, 1.8mm, zipcord cable, Yellow jacket					
21	Singlemode G657 A1 9/125um, 3.0mm, zipcord cable, Yellow jacket					
22	Singlemode G655 9/125um, 0.9mm, zipcord cable, Yellow jacket					
23	Multimode OM1 62.5/125um, 2.0mm, zipcord cable, orange jacket					
24	Singlemode B1.3 9/125um, 2.0mm, zipcord cable, Yellow jacket					
25	Singlemode G657 A1 9/125um, 2.0mm, zipcord cable, Yellow jacket					
26	Multimode OM1 62.5/125um, 1.8mm, zipcord cable, orange jacket					
27	Singlemode B1.3 9/125um, 2.0mm, Mini-zipcord cable, Yellow jacket					
28	Multimode OM3 50/125um, 0.9mm, simplex cable, White jacket					
29	Singlemode G655 9/125um, 0.9mm, simplex cable, White jacket					
30	Singlemode G655 9/125um, 1.8mm, simplex cable, Yellow jacket					
31	Singlemode G655 9/125um, 2.0mm, zipcord cable, Yellow jacket					
32	Singlemode G655 9/125um, 3.0mm, zipcord cable, Yellow jacket					
34	Multimode OM2 50/125um, 0.9mm, simplex cable, gray jacket					
35	Multimode OM2 50/125um, 3.0mm, zipcord cable, orange jacket					
40	Multimode OM4 50/125um, 0.9mm, simplex cable, White jacket					
42	Multimode OM3 50/125um, 3.0mm, zipcord cable, gray jacket					
43	Free					
44	Multimode OM3 50/125um, 3.0mm, MTRJ dualan cable, gray jacket					
45	Multimode OM3 50/125um, 2.0mm, zipcord cable, gray jacket					
46	Multimode OM3 50/125um, 1.8mm, Mini-zipcord cable, gray jacket					
47	Multimode OM3 50/125um, 0.9mm, simplex cable, gray jacket					
48	Free					
53	Free					
54	Free					

**Example:**

**LP-F13C30T3007P3M1** - Duplex Optical Patch Cord (Zipcord)  
 SC Duplex Beige color connector / PC Polish, RL > 20dB to  
 ST Simplex Beige color connector / PC Polish, RL > 20dB OM1  
 62.5/125um, 3.0mm, zipcord cable, orange jacket, PVC  
 3m length, Bendable boot.

# Order Information

**LP-F XX T P O T P O CC J LLL B**

CABLETYPE		CABLE JACKET TYPE	LENGTH		BOOT TYPE		
55	Multimode OM4 50/125um, 3.0mm, zipcord cable, gray jacket	P	PVC Jacket	10m	Meter	Blank	Standard long boot
56	Free	L	LSZH Jacket			1	Bendable boot
57	Free					2	Short boot
58	Free						
59	Free						
60	Multimode OM4 50/125um, 0.9mm, simplex cable, gray jacket						
61	Free						
65	Multimode OM3 50/125um, 3.0mm, simplex cable, aqua jacket laser optimized 10 G/G						
66	Multimode OM3 50/125um, 0.9mm, simplex cable, aqua jacket laser optimized 10 G/G						
67	Multimode OM3 50/125um, 3.0mm, zipcord cable, aqua jacket laser optimized 10 G/G						
68	Multimode OM3 50/125um, 2.0mm, simplex cable, aqua jacket laser optimized 10 G/G						
69	Multimode OM3 50/125um, 3.0mm, MTRU dualan cable, aqua jacket, laser optimized 10 G/G						
70	Multimode OM3 50/125um, 2.0mm, zipcord cable, aqua jacket laser optimized 10 G/G						
71	Multimode OM3 50/125um, 1.8mm, Mini-zipcord cable, aqua jacket laser optimized 10 G/G						
72	Free						
73	Free						
76	Multimode OM4 50/125um, 3.0mm, simplex cable, aqua jacket laser optimized 10 G/G						
77	Multimode OM4 50/125um, 0.9mm, simplex cable, aqua jacket laser optimized 10 G/G						
78	Multimode OM4 50/125um, 3.0mm, zipcord cable, aqua jacket laser optimized 10 G/G						
79	Multimode OM4 50/125um, 2.0mm, simplex cable, aqua jacket laser optimized 10 G/G						
80	Multimode OM4 50/125um, 3.0mm, MTRU dualan cable, aqua jacket laser optimized 10 G/G						
81	Multimode OM4 50/125um, 2.0mm, zipcord cable, aqua jacket laser optimized 10 G/G						
82	Multimode OM4 50/125um, 1.8mm, Mini-zipcord cable, aqua jacket laser optimized 10 G/G						
83	Free						
84	Free						

## Example:

**LP-F13C30T3007P3M1** - Duplex Optical Patch Cord (Zipcord) SC Duplex Beige color connector / PC Polish , RL > 20dB to ST Simplex Beige color connector / PC Polish , RL > 20dB OM1 62.5/125um, 3.0mm, zipcord cable, orange jacket , PVC 3m length, Bendable boot.

## Order Information

Connectors hierarchy	Polish hierarchy
LC Duplex	UPC
LC Simplex	APC
SC Simplex	PC
SC Duplex	SPC
FC Simplex	
FC Typical type simplex disassembled	
ST Simplex	
MTRJ Female	
MTRJ with Guide Pin	
E2000 Simplex	
E2000 Duplex	

**Example:**

**LP-F13C30T3007P3M1** - Duplex Optical Patch Cord (Zipcord) SC Duplex Beige color connector / PC Polish , RL > 20dB to ST Simplex Beige color connector / PC Polish , RL > 20dB OM1 62.5/125um, 3.0mm, zipcord cable, orange jacket , PVC 3m length, Bendable boot.

# Fiber Sizes & Types

## Fiber Sizes and Types

---

Fiber comes in two basic types, singlemode and multimode. Except for fibers used in specialty applications, singlemode fiber can be considered as one size and type. If you deal with long haul telecom or submarine cables, you may have to work with specialty singlemode fibers.

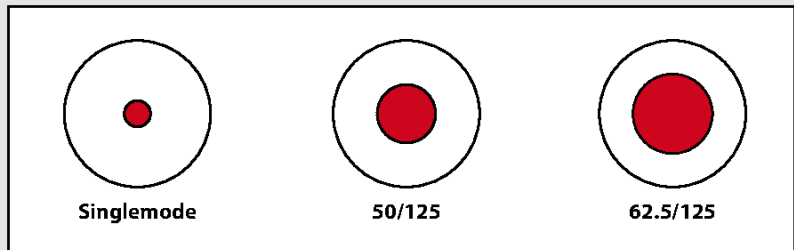

# Mini Breakout cable

LanPro Mini Breakout cable is the very compact and space saving cable distributor because the cable core is made of 12 fibers x 0.25mm and the outer cable diameter is 3.0mm. This series is particularly ideal for installation and connection of complex fiber optical infrastructures and also flexible for connections from one cabinet to another. The available fiber numbers are within 12 fibers. Asymmetric cascade version at both ends are the standard version. This standard breakout length can be staggered for better cable routing and management.

## Specifications:

- ST, FC, SC, and LC are available. PC, SPC, UPC and APC polish meet standard requirement. Available for 4, 6, 8 and 12 cores.
- Fanout length: 24 inch at both ends (total: 24 inch x 2 = 121.92 cm) and by asymmetric cascade version.

Further assemblies, fanout length and cable length available on request

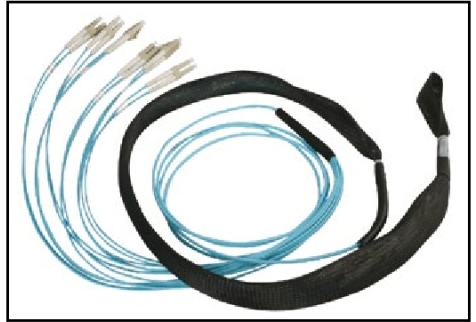

## Fiber Compatibility:

OM1, OM2, OM3, OM4, OS1/OS2

## Applications:

Provide interconnect and cross-connect of applications over installations in entrance facilities, telecommunications rooms and data center

OM1 (62.5/125um): for LED-based propagation

OM2 (50/125um): for LED or laser-based propagation

OM3 & OM4 (50/125um): for VCSEL-based propagation

OS1 & OS2 (9/125um): Laser-based propagation.

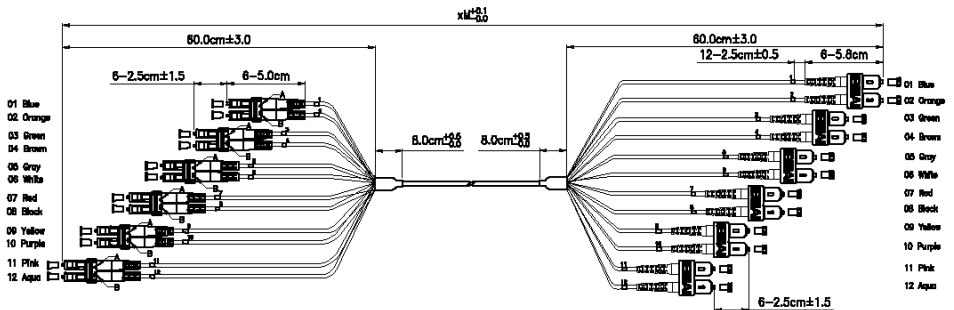

# Order Information

**LP-50 B K B A CF CF 0032**

LP-F50	FIBER TYPE		BREAKOUT CABLE TYPE		COLOR		JACKET MATERIAL		A CONECTOR	
LANPRO MINI BREAKOUT CABLE	A	4C 2.0mm Jacket	B	None	A	BL	A	PVC	AA	FC One piece (MM)
	B	MM 50/125 um	E	6C 2.0mm Jacket	B	OR	D	PVC Both end pulling eye	AB	FC One piece (MM Low Loss)
	C	10G 50/125um	H	8C 2.0mm Jacket	C	GN	E	PVC OFNP	AC	FC One piece (5M SPC)
	D	OM3 50/125um	K	12C 2.0mm Jacket	D	BR	H	PVC OFNP Both end pulling eye	AD	FC One piece (5M UPC)
	E	OM4 50/125um			E	GY	I	LSZH	AE	FC One piece (5M APC)
	F	5M(G625D) 9/125um			F	WH	L	LSZH Both end pulling eye	BA	ST (MM)
	H	5M(G67A2) 9/125um			G	RD			BB	ST (MM Low Loss)
					H	BK			BC	ST (5M SPC)
					I	YL			BD	ST (5M UPC)
					J	VT(PU)			CF	SC II w/Clip (MM)
					K	RS(PK)			CG	SC II w/Clip (MM Low Loss)
					L	AQ			CH	SC II w/Clip (5M SPC)
									CI	SC II w/Clip (5M UPC)
								CJ	SC II w/Clip (5M APC)	
								DF	LC w/Clip (MM)	
								DG	LC w/Clip (MM Low Loss)	
								DH	LC w/Clip (5M SPC)	
								DI	LC w/Clip (5M UPC)	
								DJ	LC w/Clip (5M APC)	

**Example:**

**LP-F50BKBACFCF0032** Fiber Optic Mini Breakout cable, Multimode 50/125um, 12C 2.0mm PVC Orange color jacket, FC one piece MM to FC one piece MM, 3m length.



## Order Information

**LP-50 B K B A CF CF 0032**

B CONECTOR		LENGTH	
AA	FC One piece (MM)	0032	3M
AB	FC One piece (MM Low Loss)	0052	5M
AC	FC One piece (5M SPC)	0102	10M
AD	FC One piece (5M UPC)	0152	15M
AE	FC One piece (5M APC)	0202	20M
BA	ST (MM)	0252	25M
BB	ST (MM Low Loss)		
BC	ST (5M SPC)		
BD	ST (5M UPC)		
CF	SC II w/Clip (MM)		
CG	SC II w/Clip (MM Low Loss)		
CH	SC II w/Clip (5M SPC)		
CI	SC II w/Clip (5M UPC)		
CJ	SC II w/Clip (5M APC)		
DF	LC w/Clip (MM)		
DG	LC w/Clip (MM Low Loss)		
DH	LC w/Clip (5M SPC)		
DI	LC w/Clip (5M UPC)		
DJ	LC w/Clip (5M APC)		

**Example:**

**LP-F50BKBACFCF0032** Fiber Optic Mini Breakout cable, Multimode 50/125um, 12C 2.0mm PVC Orange color jacket, FC one piece MM to FC one piece MM, 3m length.

# Breakout cable

LanPro Breakout cables, also called distribution cable, similar to Mini Breakout cables, provide two heart sizes of tube: 0.9mm, 2.0mm. Compared with Mini Breakout cables, the core fiber diameter of this Breakout cables are bigger than Mini Breakout cables (Mini Breakout cable 12 core: 3.0mm and Breakout cable 12 core: 6.5 mm). LanPro Breakout cable are for the purpose of extended length and backbone in data centers, are suitable for connection from one cabinet/zone to another, such as MDA and HDA. The standard breakout length can be staggered for better cable routing and management.

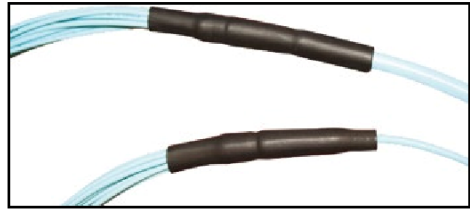

The upper one is a Breakout cable and the bottom one is a Mini Breakout Cable

## Specifications:

- ST, FC, SC, and LC are available. PC, SPC, UPC and APC polish meet standard requirement. Available for 24, 36 and 48 fibers (further assemblies available on request)

- Fanout length: 24 inch at both ends (total: 24 inch x 2 = 121.92 cm) and by asymmetric cascade version

Further assemblies, fanout length and cable length available on request.

## Applications:

Provide interconnect and cross-connect of applications over installations in entrance facilities, telecommunications rooms and data center.

- OM1 (62.5/125um): for LED-based propagation
- OM2 (50/125um): for LED or laser-based propagation
- OM3 & OM4 (50/125um): for VCSEL-based propagation
- OS1 & OS2 (9/125um): Laser-based propagation.

## Fiber Compatibility:

OM1, OM2, OM3, OM4, OS1/OS2

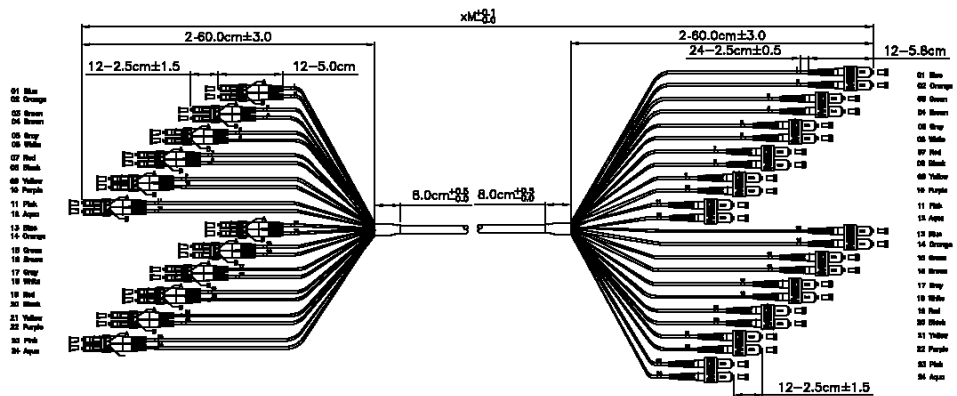

# Order Information

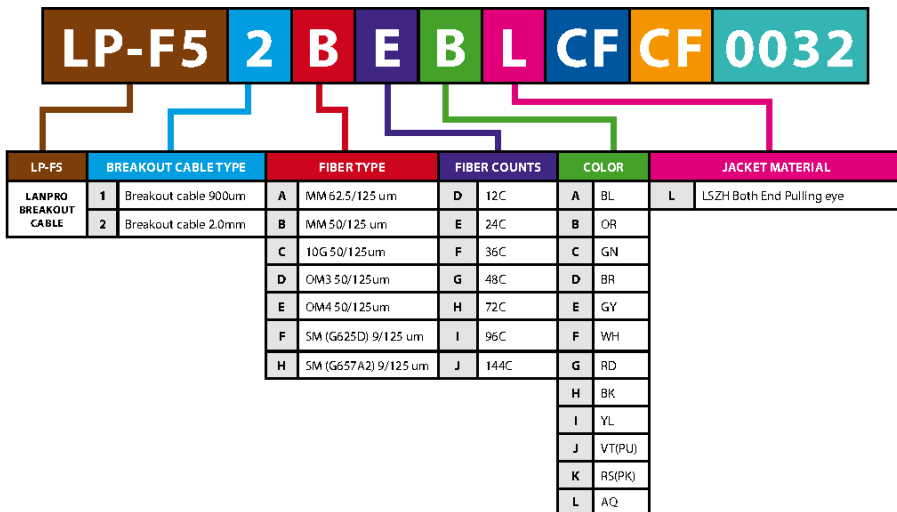

**Example:**

**LP-F52BEBL CFCF0032** Fiber Optic Breakout cable, 2.0mm Multimode 50/125um, 24C LSZH both end pulling eye Orange color jacket, SC II w/Clip MM to SC II w/Clip MM, 3m length.

## Order Information

**LP-F5 2 B E B L C F C F 0032**

A CONECTOR		B CONECTOR		LENGTH	
AA	FC One piece (MM)	AA	FC One piece (MM)	0032	3M
AB	FC One piece (MM Low Loss)	AB	FC One piece (MM Low Loss)	0052	5M
AC	FC One piece (SM SPC)	AC	FC One piece (SM SPC)	0102	10M
AD	FC One piece (SM UPC)	AD	FC One piece (SM UPC)	0152	15M
AE	FC One piece (SM APC)	AE	FC One piece (SM APC)	0202	20M
BA	ST (MM)	BA	ST (MM)	0252	25M
BB	ST (MM Low Loss)	BB	ST (MM Low Loss)	0302	30M
BC	ST (SM SPC)	BC	ST (SM SPC)	0402	40M
BD	ST (SM UPC)	BD	ST (SM UPC)	0502	50M
CF	SC II w/Clip (MM)	CF	SC II w/Clip (MM)	0602	60M
CG	SC II w/Clip (MM Low Loss)	CG	SC II w/Clip (MM Low Loss)	0702	70M
CH	SC II w/Clip (SM SPC)	CH	SC II w/Clip (SM SPC)	0802	80M
CI	SC II w/Clip (SM UPC)	CI	SC II w/Clip (SM UPC)	0902	90M
CJ	SC II w/Clip (SM APC)	CJ	SC II w/Clip (SM APC)	1002	100M
DF	LC w/Clip (MM)	DF	LC w/Clip (MM)		
DG	LC w/Clip (MM Low Loss)	DG	LC w/Clip (MM Low Loss)		
DH	LC w/Clip (SM SPC)	DH	LC w/Clip (SM SPC)		
DI	LC w/Clip (SM UPC)	DI	LC w/Clip (SM UPC)		
DJ	LC w/Clip (SM APC)	DJ	LC w/Clip (SM APC)		

### Example:

**LP-F52BEBLCFCF0032** Fiber Optic Breakout cable, 2.0mm Multimode 50/125um, 24C LSZH both end pulling eye Orange color jacket, SC II w/Clip MM to SC II w/Clip MM, 3m length.

LanPro provides an extensive and complete line of high-density MTP® and MPO multi fiber connectors products, including jumpers, fanouts and pre-terminated solution. The singlemode and Multimode by low loss for MTP® and MPO connectors deliver the performance and reliability to answer today's demanding about high-speed broadband and data networks. MTP® and MPO maximize the capacity in data center, increasing fiber density on fiber shelves and faceplates and also improving and simplifying fiber routing.

## Specifications:

- MTP® and MPO are available. PC and APC polish meet standard requirement. Available for 8 and 12 fibers (further assemblies, 24 fibers available on request)
- Support Method A, B, C and option for male and female for MTP®/MPO.

Further assemblies, fanout length and cable length available on request.

## Fiber Compatibility:

OM1, OM2, OM3, OM4, OS1/OS2

## Applications:

Reliable high-density interconnection for: Data communications networks, including high-bandwidth equipment, interconnections for parallel optical transmitters and receivers, telecommunications networks and broadband/CATV networks.

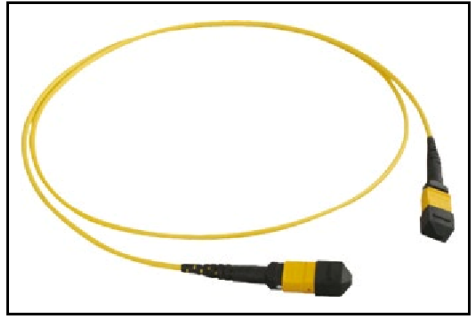

With pin, it is male

1. Connector 1: MTP® multimode, female connector, low loss
2. Connector 2: MTP® multimode, male connector, low loss
3. Cable type: 12C Ø3.0mm round cable, OM3 50/125um multimode, LSZH material, Aqua color
4. Length: x Meter

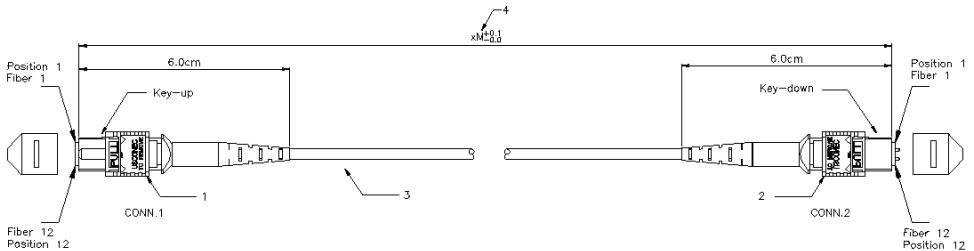

# Order Information

**LP-53 D F L A A A A 0032**

LP-F53	FIBERTYPE		CABLE TYPE		COLOR		JACKET MATERIAL		A CONNECTOR	
LANPRO ARRAY CABLES	C	10G 50/125um	B	8C-5.0x2.5mm-Flat-Simplex Ribbon	A	BL	A	PVC	AA	12 F MTP* (MM)
	D	OM3 50/125um	C	8C-Round Cable	B	OR	E	PVC OFNP	AB	12 F MTP* (MM Low Loss)
	E	OM4 50/125um	E	12C-5.0x2.5mm-Flat-Simplex Ribbon	C	GN	I	LSZH	AC	12 F MTP* (5M APC)
	F	5M(G652D) 9/125um	F	12C-3.0mm Round Cable	D	BR			AD	12 F MTP* (5M APC Low Loss)
	H	5M(G657A2) 9/125um	I	24C-Round Cable	E	GY			BA	12 F MPO (MM)
					F	WH			BB	12 F MPO (MM Low Loss)
					G	RD			BC	12 MPO (5M APC)
					H	BK			BD	12 F MPO (5M APC Low Loss)
					I	YL			CA	24 F MTP* (MM)
					J	VT(PU)			CB	24 F MTP* (MM Low Loss)
				K	R5(PK)			CC	24 F MTP* (5M APC)	
				L	AQ			CD	24 F MTP* (5M APC Low Loss)	
								DA	24 F MPO (MM)	
								DB	24 F MPO (MM Low Loss)	
								DC	24 F MPO (5M APC)	
								DD	24 F MPO (5M APC Low Loss)	

**Example:**

**LP-F53DFLAAAA0032** Fiber Optic Array Cable, OM3 50/125 um, 12C-3.0mm round cable, PVC aqua color jacket, 12 F MTP® MM to 12 F MTP® MM Method A, 3m length.

# Order Information

**LP-53 D F L A AA AA 0032**

B CONECTOR				LENGTH	
AA	12 F MTP* (MM) Method A	AA	24 F MTP* (MM) Method A	0012	1M
AB	12 F MTP* (MM Low Loss) Method A	AB	24 F MTP* (MM Low Loss) Method A	0014	1.5M
AC	12 F MTP* (SM APC) Method A	AC	24 F MTP* (SM APC) Method A	0022	2M
AD	12 F MTP* (SM APC Low Loss) Method A	AD	24 F MTP* (SM APC Low Loss) Method A	0032	3M
AE	12 F MTP*+Guide Pin (MM) Method A	AE	24 F MTP*+Guide Pin (MM) Method A	0052	5M
AF	12 F MTP*+Guide Pin (MM Low Loss) Method A	AF	24 F MTP*+Guide Pin (MM Low Loss) Method A	0102	10M
AG	12 F MTP*+Guide Pin (SM APC) Method A	AG	24 F MTP*+Guide Pin (SM APC) Method A	0152	15M
AH	12 F MTP*+Guide Pin (SM APC Low Loss) Method A	AH	24 F MTP*+Guide Pin (SM APC Low Loss) Method A	0202	20M
BA	12 F MTP* (MM) Method B	BA	24 F MTP* (MM) Method B	0252	25M
BB	12 F MTP* (MM Low Loss) Method B	BB	24 F MTP* (MM Low Loss) Method B		
BE	12 F MTP*+Guide Pin (MM) Method B	BE	24 F MTP*+Guide Pin (MM) Method B		
BF	12 F MTP*+Guide Pin (MM Low Loss) Method B	BF	24 F MTP*+Guide Pin (MM Low Loss) Method B		
CA	12 F MTP* (MM) Method C	CA	24 F MTP* (MM) Method C		
CB	12 F MTP* (MM Low Loss) Method C	CB	24 F MTP* (MM Low Loss) Method C		
CC	12 F MTP* (SM APC) Method C	CC	24 F MTP* (SM APC) Method C		
CD	12 F MTP* (SM APC Low Loss) Method C	CD	24 F MTP* (SM APC Low Loss) Method C		
CE	12 F MTP*+Guide Pin (MM) Method C	CE	24 F MTP*+Guide Pin (MM) Method C		
CF	12 F MTP*+Guide Pin (MM Low Loss) Method C	CF	24 F MTP*+Guide Pin (MM Low Loss) Method C		
CG	12 F MTP*+Guide Pin (SM APC) Method C	CG	24 F MTP*+Guide Pin (SM APC) Method C		
CH	12 F MTP*+Guide Pin (SM APC Low Loss) Method C	CH	24 F MTP*+Guide Pin (SM APC Low Loss) Method C		
AA	12 F MPO (MM) Method A	AA	24 F MPO (MM) Method A		
AB	12 F MPO (MM Low Loss) Method A	AB	24 F MPO (MM Low Loss) Method A		
AC	12 F MPO (SM APC) Method A	AC	24 F MPO (SM APC) Method A		
AD	12 F MPO (SM APC Low Loss) Method A	AD	24 F MPO (SM APC Low Loss) Method A		
AE	12 F MPO+Guide Pin (MM) Method A	AE	24 F MPO+Guide Pin (MM) Method A		
AF	12 F MPO+Guide Pin (MM Low Loss) Method A	AF	24 F MPO+Guide Pin (MM Low Loss) Method A		
AG	12 F MPO+Guide Pin (SM APC) Method A	AG	24 F MPO+Guide Pin (SM APC) Method A		
AH	12 F MPO+Guide Pin (SM APC Low Loss) Method A	AH	24 F MPO+Guide Pin (SM APC Low Loss) Method A		
BA	12 F MPO+Guide Pin (SM APC Low Loss) Method A	BA	24 F MPO (MM) Method B		
BB	12 F MPO (MM Low Loss) Method B	BB	24 F MPO (MM Low Loss) Method B		
BE	12 F MPO+Guide Pin (MM) Method B	BE	24 F MPO+Guide Pin (MM) Method B		
BF	12 F MPO+Guide Pin (MM Low Loss) Method B	BF	24 F MPO+Guide Pin (MM Low Loss) Method B		
CA	12 F MPO (MM) Method C	CA	24 F MPO (MM) Method C		
CB	12 F MPO (MM Low Loss) Method C	CB	24 F MPO (MM Low Loss) Method C		
CC	12 F MPO (SM APC) Method C	CC	24 F MPO (SM APC) Method C		
CD	12 F MPO (SM APC Low Loss) Method C	CD	24 F MPO (SM APC Low Loss) Method C		
CE	12 F MPO+Guide Pin (MM) Method C	CE	24 F MPO+Guide Pin (MM) Method C		
CF	12 F MPO+Guide Pin (MM Low Loss) Method C	CF	24 F MPO+Guide Pin (MM Low Loss) Method C		
CG	12 F MPO+Guide Pin (SM APC) Method C	CG	24 F MPO+Guide Pin (SM APC) Method C		
CH	12 F MPO+Guide Pin (SM APC Low Loss) Method C	CH	24 F MPO+Guide Pin (SM APC Low Loss) Method C		

**Example:**  
**LP-F53DFLAAAA0032**  
 Fiber Optic Array Cable, OM3  
 50/125 um, 12C-3.0mm round  
 cable, PVC aqua color jacket,  
 12 F MTP\* MM to 12 F MTP\* MM  
 Method A, 3m length.

LanPro Trunk cable assemblies allow for a rapid deployment of high-density permanent links in a single assembly for data center applications demanding quick infrastructure deployment, such as main, horizontal and zone distribution areas. LanPro Trunk series optimizes cable routing to guarantee efficient use of pathway space and significantly reduce installation time and cost. It is built with modular MTP®/ MPO connectivity and supports compatibility, flexibility and system performance in all permanent link applications. LanPro Trunk is factory terminated and tested to deliver verified optical performance and reliability for improved network integrity.

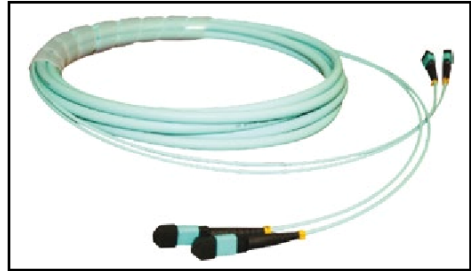

## Specifications:

- MTP® and MPO are available. PC and APC polish meet standard requirement. 8 ~144 fibers are available (further assemblies, 24 fibers available on request)
- Support method A, B, C and option for male and female for MTP®/MPO

Fanout length: 24 inch at one end (total: 24 inch x 1 = 60.96 cm) and by asymmetric cascade version, including pulling eyes.

Further assemblies, fanout length and cable length available on request.

## Applications:

Tailor configuration and breakout construction to application requirements to minimize waste, optimize cable management, speed deployment and improve flexibility and manageability for lower installation costs.

Reliable high-density interconnection for: Data communications networks, including high-bandwidth equipment, interconnections for parallel optical transmitter and receivers, telecommunications networks and broadband/ CATV networks.

## Fiber Compatibility:

OM1, OM2, OM3, OM4, OS1/OS2

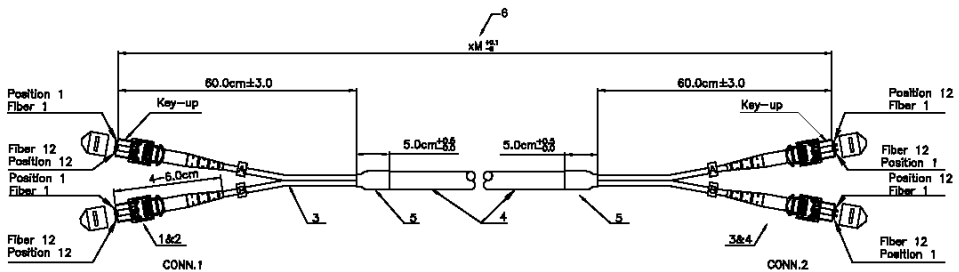

1. Connector 1 & 2: MTP® Multimode, female connector
2. Connector 3 & 4: MTP® Multimode, male connector
3. Cable type: 12C Ø3.0mm round cable, OM3 50/125um multimode, PVC material, aqua color
4. Cable type: 24C Ø9.0mm trunk cable, OM3 50/125um multimode, PVC material, aqua color
5. Heat shrink tubing length: 5.0cm
6. Length: x Meter



# Order Information

LP-F54	FIBER TYPE		FIBER COUNTS		COLOR		JACKET MATERIAL	A CONECTOR		
LANPRO TRUNK CABLE	C	10G 50/125um	A	82C	A	BL	C	PVC End B Pulling eye	AA	12 F MTP* (MM)
	D	OM3 50/125um	B	12C	B	OR	G	PVC OFNP End Pulling eye	AB	12 F MTP* (MM Low Loss)
	E	OM4 50/125um	C	24C	C	GN	K	LSZH End B Pulling eye	AC	12 F MTP* (SM APC)
	F	5M(G652D) 9/125um	D	36C	D	BR			AD	12 F MTP* (SM APC Low Loss)
	H	5M(G657A2) 9/125um	E	48C	E	GY			BA	12 F MPO (MM)
			F	72C	F	WH			BB	12 F MPO (MM Low Loss)
			G	96C	G	RD			BC	12 F MPO (SM APC)
			H	144C	H	BK			BD	12 F MPO (SM APC Low Loss)
			I	196C	I	YL			CA	24F MTP* (MM)
			J	288C	J	VT (PU)			CB	24F MTP* (MM Low Loss)
			K	RS (PK)					CC	24F MTP* (SM APC)
			L	AQ					CD	24F MTP* (SM APC Low Loss)
							DA	24F MTO (MM)		
							DB	24F MTO (MM Low Loss)		
						DC	24F MTO (SM APC)			
						DD	24F MTO (SM APC Low Loss)			

**Example:**

**LP-F54DBLCAAA0102** Fiber Optic Trunk cable. OM3 50/125um, 12C, PVC end B pulling eye Aqua color jacket, 12 F MTP\* MM to 12 F MTP\* MM Method A, 10m length.

# Order Information

**LP-F54 D B L C AA AA 0102**

B CONNECTOR				LENGTH	
AA	12 F MTP® (MM) Method A	AA	24 F MTP® (MM) Method A	0032	3m
AB	12 F MTP® (MM Low Loss) Method A	AB	24 F MTP® (MM Low Loss) Method A	0052	5m
AC	12 F MTP® (5M APC) Method A	AC	24 F MTP® (5M APC) Method A	0102	10m
AD	12 F MTP® (5M APC Low Loss) Method A	AD	24 F MTP® (5M APC Low Loss) Method A	0202	20m
AE	12 F MTP®+Guide Pin (MM) Method A	AE	24 F MTP®+Guide Pin (MM) Method A	0302	25m
AF	12 F MTP®+Guide Pin (MM Low Loss) Method A	AF	24 F MTP®+Guide Pin (MM Low Loss) Method A	0402	30m
AG	12 F MTP®+ Guide Pin (5M APC) Method A	AG	24 F MTP®+ Guide Pin (5M APC) Method A	0502	40m
AH	12 F MTP®+ Guide Pin (5M APC Low Loss) Method A	AH	24 F MTP®+ Guide Pin (5M APC Low Loss) Method A	0602	50m
BA	12 F MTP® (MM) Method B	BA	24 F MTP® (MM) Method B	0702	60m
BB	12 F MTP® (MM Low Loss) Method B	BB	24 F MTP® (MM Low Loss) Method B	0802	80m
BE	12 F MTP®+Guide Pin (MM) Method B	BE	24 F MTP®+Guide Pin (MM) Method B	0902	90m
BF	12 F MTP®+Guide Pin (MM Low Loss) Method B	BF	24 F MTP®+Guide Pin (MM Low Loss) Method B	1002	100m
CA	12 F MTP® (MM) Method C	CA	24 F MTP® (MM) Method C		
CB	12 F MTP® (MM Low Loss) Method C	CB	24 F MTP® (MM Low Loss) Method C		
CC	12 F MTP® (5M APC) Method C	CC	24 F MTP® (5M APC) Method C		
CD	12 F MTP® (5M APC Low Loss) Method C	CD	24 F MTP® (5M APC Low Loss) Method C		
CE	12 F MTP®+ Guide Pin (MM) Method C	CE	24 F MTP®+Guide Pin (MM) Method C		
CF	12 F MTP®+ Guide Pin (MM Low Loss) Method C	CF	24 F MTP®+Guide Pin (MM Low Loss) Method C		
CG	12 F MTP®+ Guide Pin (5M APC) Method C	CG	24 F MTP®+Guide Pin (5M APC) Method C		
CH	12 F MTP®+ Guide Pin (5M APC Low Loss) Method C	CH	24 F MTP®+Guide Pin (5M APC Low Loss) Method C		
AA	12 F MPO (MM) Method A	AA	24 F MPO (MM) Method A		
AB	12 F MPO (MM Low Loss) Method A	AB	24 F MPO (MM Low Loss) Method A		
AC	12 F MPO (5M APC) Method A	AC	24 F MPO (5M APC) Method A		
AD	12 F MPO (5M APC Low Loss) Method A	AD	24 F MPO (5M APC Low Loss) Method A		
AE	12 F MPO+Guide Pin (MM) Method A	AE	24 F MPO+Guide Pin (MM) Method A		
AF	12 F MPO+Guide Pin (MM Low Loss) Method A	AF	24 F MPO+Guide Pin (MM Low Loss) Method A		
AG	12 F MPO+Guide Pin (5M APC) Method A	AG	24 F MPO+Guide Pin (5M APC) Method A		
AH	12 F MPO+Guide Pin (5M APC Low Loss) Method A	AH	24 F MPO+Guide Pin (5M APC Low Loss) Method A		
BA	12 F MPO+Guide Pin (5M APC Low Loss) Method A	BA	24 F MPO (MM) Method B		
BB	12 F MPO (MM Low Loss) Method B	BB	24 F MPO (MM Low Loss) Method B		
BE	12 F MPO+Guide Pin (MM) Method B	BE	24 F MPO+Guide Pin (MM) Method B		
BF	12 F MPO+Guide Pin (MM Low Loss) Method B	BF	24 F MPO+Guide Pin (MM Low Loss) Method B		
CA	12 F MPO (MM) Method C	CA	24 F MPO (MM) Method C		
CB	12 F MPO (MM Low Loss) Method C	CB	24 F MPO (MM Low Loss) Method C		
CC	12 F MPO (5M APC) Method C	CC	24 F MPO (5M APC) Method C		
CD	12 F MPO (5M APC Low Loss) Method C	CD	24 F MPO (5M APC Low Loss) Method C		
CE	12 F MPO+Guide Pin (MM) Method C	CE	24 F MPO+Guide Pin (MM) Method C		
CF	12 F MPO+Guide Pin (MM Low Loss) Method C	CF	24 F MPO+Guide Pin (MM Low Loss) Method C		
CG	12 F MPO+Guide Pin (5M APC) Method C	CG	24 F MPO+Guide Pin (5M APC) Method C		
CH	12 F MPO+Guide Pin (5M APC Low Loss) Method C	CH	24 F MPO+Guide Pin (5M APC Low Loss) Method C		

**Example:**

**LP-F54DBLCAAAA0102**

Fiber Optic Trunk cable, OM3 50/125um, 12C, PVC end B pulling eye Aqua color jacket, 12 F MTP® MM to 12 F MTP® MM Method A, 10m length.

# Direct Harness

LanPro Direct Harness has a pinned (male) MTP®/MPO connector on one end and while the other end is equipped with single or dual fiber connectors. Direct harness converts MTP®/MPO terminations to simplex fiber connectors such as LC or SC.

This series is for installing inside plug-&-play fiber cassette module, assembled with 0.9 mm cable to single-fiber connectors. All types of fiber connector interface are available for choices and allow for maximum fiber density within a limited space. This series is factory tested. Incorporating with cassette solution, LanPro Direct Harness can reduce installation time by up to 75 percent.

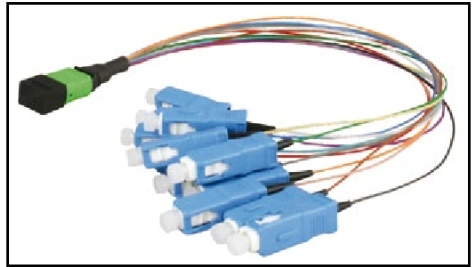

## Specifications:

Fiber connector interface available in ST, SC, FC, LC, MTP® and MPO in forms of simplex channeling (further assemblies, 24 fibers MTP®/MPO available on request).

## Fiber Compatibility:

OM1, OM2, OM3, OM4, OS1/OS2

## Applications:

Tailor configuration and breakout construction to application requirements to minimize waste, optimize cable management, speed deployment and improve flexibility and manageability for lower installation costs.

Reliable high-density interconnection for: Data communications networks, including high-bandwidth equipment, interconnection for parallel optical transmitters and receivers, telecommunications networks and broadband/CATV networks.

OM3 & OM4 (50/125 um): for VCSEL-based propagation  
OS1/OS2 (9/125um): Laser-based propagation

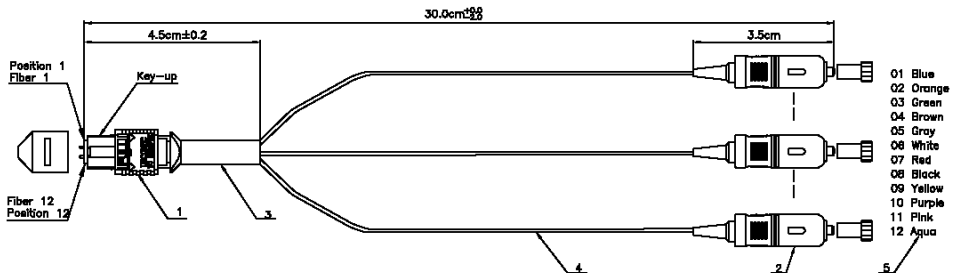

1. Connector type: Guide pin MTP® multimode, male connector, low loss
2. Connector type: SC multimode, ivory color, low loss
3. Shrink tube: 1.5cm, use black heat shrink tube
4. Tube type: Ø0.9mm/hytrel, 12 color
5. Fanout MTP® (Male) to SC OM3 12C patch cord 30cm  
1(blue)/2(orange)/3(green)/4(brown)/5(gray)/6(white)/7(red)/8(black)/9(yellow)/10(purple)/11(pink)/12(aqua)

# Order Information

**LP-F55 C D M A AA DA 0301**

LP-F55	FIBERTYPE	CABLETYPE	COLOR	JACKET MATERIAL	A CONECTOR		B CONECTOR		LENGTH					
LANPRO DIRECT HARNESS	C	10G 50/125um	D	12C, 0.9mm Jacket	M	12 colors	A	PVC	AA	12 F MTP* (MM)	AA	FC One Piece (MM)	<b>0301</b>	30cm
	D	OM3 50/125um							AB	12 F MTP* (MM Low Loss)	AB	FC One Piece (MM Low Loss)	<b>0501</b>	50cm
	E	OM4 50/125um							AC	12 F MTP* (SM APC)	AC	FC One Piece (SM SPC)		
	F	SM(G652D) 9/125um							AD	12 F MTP* (SM APC Low Loss)	AD	FC One Piece (SM UPC)		
	H	SM(G657A2) 9/125um							AE	12 F MTP*+Guide Pin (MM)	AE	FC One Piece (SM APC)		
									AF	12 F MTP*+Guide Pin (MM Low Loss)	BA	ST (MM)		
									AG	12 F MTP*+Guide Pin (SM APC)	BB	ST (MM Low Loss)		
									AH	12 F MTP*+Guide Pin (SM APC Low Loss)	BC	ST (SM SPC)		
									BA	12 F MPO (MM)	BD	ST (SM UPC)		
									BB	12 F MPO (MM Low Loss)	CA	SCII (MM)		
									BC	12 F MPO (SM APC)	CB	SCII (MM Low Loss)		
									BD	12 F MPO (SM APC Low Loss)	CC	SCII (SM SPC)		
									BE	12 F MPO+Guide Pin (MM)	CD	SCII (SM UPC)		
									BF	12 F MPO+Guide Pin (MM Low Loss)	CE	SCII (SM APC)		
									BG	12 F MPO+Guide Pin (SM APC)	DA	LC (MM)		
									BH	12 F MPO+Guide (SM APC Low Loss)	DB	LC (MM Low Loss)		
											DC	LC (SM SPC)		
											DD	LC (SM UPC)		
											DE	LC (SM APC)		

**Example:**

**LP-F55CDMAADA0301** Fiber Optic Direct Harness, 10G 50/125um, 12C, 0.9mm PCV jacket, 12F MTP® MM to LC MM, 30cm length.

LanPro Harness series is for transition from trunk backbone assemblies to fiber rack system. MTP®/MPO on one end, with single-fiber connectors on another end. MTP®/MPO in 12 or 24-fiber interface is available for choices. Fiber connector interface available in ST, SC, FC and LC in forms of simplex or duplex channeling.

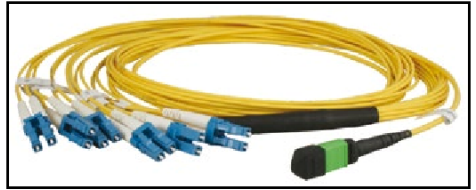

## Specifications:

Fiber connector interface available in ST, SC, FC, LC, MTP® and MPO in forms of simplex or duplex channeling (further assemblies, 24 fibers MTP®/MPO available on request)

Fanout length: 24 inch at one end (total: 24 inch x 1 = 60.96cm) and by asymmetric cascade version

## Fiber Compatibility:

OM1, OM2, OM3, OM4, OS1/OS2

## Applications:

Tailor configuration and breakout construction to application requirements to minimize waste, optimize cable management, speed deployment and improve flexibility and manageability for lower installation costs.

Reliable high-density interconnection for: Data communications networks, including high-bandwidth equipment, interconnections for parallel optical transmitters and receivers, telecommunications networks and broadband/CATV networks.

OM2 (50/125um): for LED or laser-based propagation  
 OM3 & OM4 (50/125um): for VCSEL-based propagation  
 OS1/OS2 (9/125um): Laser-based propagation.

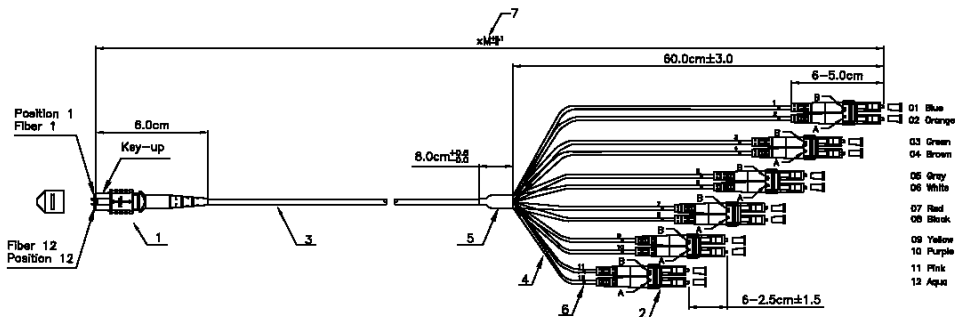

1. Connector type: MPO Multimode, male connector
2. Connector type: LC multimode, ivory color
3. Cable type: 12C Ø3.0mm round cable, OM3 50/125um multimode, LSZH material, aqua color
4. Tube type: Ø0.9mm/Hytrel, Ø2.0mm LSZH material, aqua color
5. Heat Shrink Tubing length: 8.0cm
6. Marking Tubing Length: 1.0cm
7. Length: x Meter

# Order Information

**LP-F56 D E L A AA DF 0102**

LP-F56	FIBER TYPE	BREAKOUT CABLE TYPE	COLOR	JACKET MATERIAL	A CONECTOR	B CONECTOR	LENGTH							
LANPRO HARNESS	C	10G 50/125um	C	8C-Round Cable, 3.0mm Jacket	A	BL	A	PVC	AA	12 F MTP* (MM)	AA	FC One Piece (MM)	0022	2m
	D	OM350/125um	E	12C-Round Cable, 2.0mm Jacket	B	OR	C	PVC End B Pulling Eye	AB	12 F MTP* (MM Low Loss)	AB	FC One Piece (MM Low Loss)	0032	3m
	E	OM450/125um			C	GN	E	PVC OFNP	AC	12 F MTP* (5M APC)	AC	FC One Piece (5M SPC)	0052	5m
	F	5M(G652D) 9/125um			D	BR	G	PVC OFNP End B Pulling eye	AD	12 F MTP* (5M APC Low Loss)	AD	FC One Piece (5M UPC)	0102	10m
	H	5M(G637A2) 9/125um			E	GY	I	LSZH	AE	12 F MTP*+Guide Pin (MM)	AE	FC One Piece (5M APC)	0152	15m
					F	WH	K	LSZH End B Pulling eye	AF	12 F MTP*+Guide Pin (MM Low Loss)	BA	ST (MM)	0202	20m
					G	RD			AG	12 F MTP*+Guide Pin (5M APC)	BB	ST (MM Low Loss)	0252	25m
					H	BK			AH	12 F MTP*+Guide Pin (5M APC Low Loss)	BC	ST (5M SPC)		
					I	YL			BA	12 F MPO (MM)	BD	ST (5M UPC)		
					J	VT(PU)			BB	12 F MPO (MM Low Loss)	CF	SCII w/Clip (MM)		
					K	RS(PK)			BC	12 F MPO (5M APC)	CG	SCII w/Clip (MM Low Loss)		
					L	AQ			BD	12 F MPO (5M APC Low Loss)	CH	SCII w/Clip (5M SPC)		
									BE	12 F MPO+Guide Pin (MM)	CJ	SCII w/Clip (5M UPC)		
								BF	12 F MPO+Guide Pin (MM Low Loss)	CE	SCII w/Clip (5M APC)			
								BG	12 F MPO+Guide Pin (5M APC)	DF	LC w/Clip (MM)			
								BH	12 F MPO+Guide (5M APC Low Loss)	DG	LC w/Clip (MM Low Loss)			
										DH	LC w/Clip (5M SPC)			
										DI	LC w/Clip (5M UPC)			
										DJ	LC w/Clip (5M APC)			

**Example:**

**LP-F56DELAADF0102** Fiber Optic Harness, OM3 50/125um, 12C-Round cable, 2.0mm PVC jacket, 12F MTP\* MM to LC w/Clip MM, 10m length.

# Trunk Harness

LanPro Trunk Harness Series is for backbone installation. LanPro provides a complete set of choices for fiber connector's interface. MTP®/ MPO in 12 or 24 fiber connectors interface are available and pulling eyes design to fit for different environment. Similar to LanPro Harness series, LanPro Trunk Harness supports desire cable, such as round or mini-core cable structure to eliminate bend sensitivity.

## Specifications:

Fiber connector interface available in ST, SC, FC, LC, MTP® and MPO in forms of simplex or duplex channeling (further assemblies, 24 fibers MTP®/MPO available on request).

## Fiber Compatibility:

OM1, OM2, OM3, OM4, OS1/OS2

## Applications:

Tailor configuration and breakout construction to application requirements to minimize waste, optimize cable management, speed deployment and improve flexibility and manageability for lower installation costs. Reliable high-density interconnection for: Data communications networks, including high-bandwidth equipment, interconnections for parallel optical transmitters and

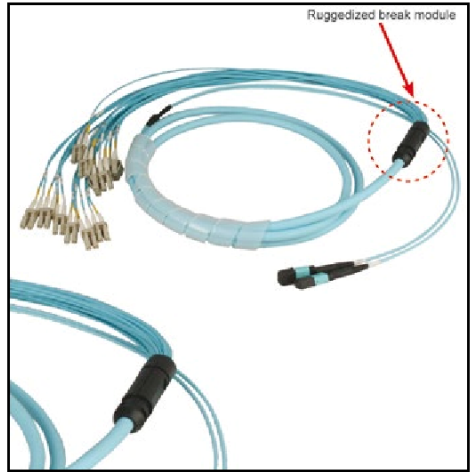

receivers, telecommunications networks and broadband/ CATV networks.

OM2 (50/125 um): for LED or laser-based propagation  
 OM3 & OM4 (50/125um): for VCSEL-based propagation  
 OS1/OS2 (9/12um): Laser-based propagation.

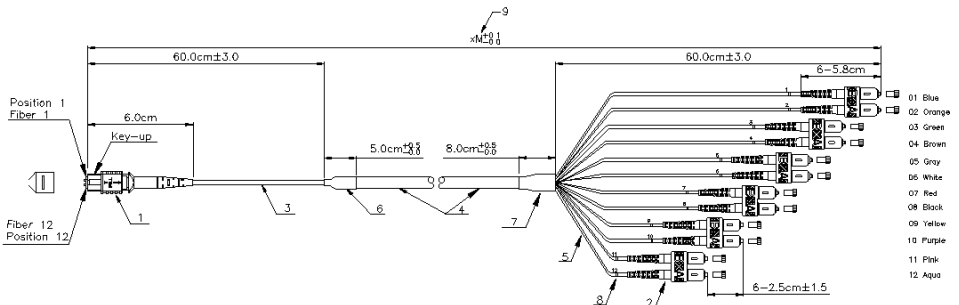

1. Connector type: MPO Multimode, male connector, low loss
2. Connector type: SC multimode, ivory color, low loss
3. Cable type: 12C Ø3.0mm round cable, OM3 50/125um multimode, LSZH material, aqua color
4. Cable type: 12C Ø6.5mm, trunk cable, OM3 50/125um multimode, LSZH material, aqua color
5. Tubing type: Ø0.9mm/Hytrel, Ø2.0mm LSZH material, aqua color
6. Heat shrink tubing length: 5.0cm
7. Option: 8.0cm Heat shrink tubing or Ruggedized break module
8. Marking Tubing length: 1.0cm
9. Length: x Meter

# Order Information

**LP-F57 D D L C AA DF 0052**

LP-F57	FIBER TYPE	FIBER COUNTS	COLOR	JACKET MATERIAL	A CONECTOR		
LANPRO TRUNK HARNESS	C	10G 50/125um	A 8C	A BL	C PVC End B Pulling eye	AA 12 F MTP* (MM)	
	D	OM3 50/125um	B 12C	B OR	G PVC OFNP End B Pulling eye	AB 12 F MTP* (MM Low Loss)	
	E	OM4 50/125um	C 24C	C GN	K LSZH End B Pulling eye	AC 12 F MTP* (SM APC)	
	F	5M(G652D) 9/125um	D 36C	D BR		AD 12 F MTP* (SM APC Low Loss)	
	H	5M(G657A2) 9/125um	E	48C	E GY		AE 12 F MTP*+Guide Pin (MM)
			F	72C	F WH		AF 12 F MTP*+Guide Pin (MM Low Loss)
			G	96C	G RD		AG 12 F MTP*+Guide Pin (SM APC)
			H	144C	H BK		AH 12 F MTP*+Guide Pin (SM APC Low Loss)
			I	YL			BA 12 F MPO (MM)
			J	VT(PU)			BB 12 F MPO (MM Low Loss)
			K	RS(PK)			BC 12 F MPO (SM APC)
			L	AQ			BD 12 F MPO (SM APC Low Loss)
					BE 12 F MPO+Guide Pin (MM)		
				BF 12 F MPO+Guide Pin (MM Low Loss)			
				BG 12 F MPO+Guide Pin (SM APC)			
				BH 12 F MPO+Guide Pin (SM APC Low Loss)			

**Example:**

**LP-F57DDLCAADF0052** Fiber Optic Trunk Harness, OM3 50/125um, 36C, PCV end B pulling eye Aqua jacket, 12F MTP\* MM to LC w/Clip MM, 5m length.



## Order Information

**LP-F57 D D L C AA DF 0052**

B CONECTOR		LENGTH	
AA	FC One Piece (MM)	0032	3M
AB	FC One Piece (MM Low Loss)	0052	5M
AC	FC One Piece (5M SPC)	0102	10M
AD	FC One Piece (5M UPC)	0152	15M
AE	FC One Piece (5M APC)	0202	20M
BA	ST (MM)	0252	25M
BB	ST (MM Low Loss)	0302	30M
BC	ST (5M SPC)	0402	40M
BD	ST (5M UPC)	0502	50M
CF	SCII w/Clip (MM)	0602	60M
CG	SCII w/Clip (MM Low Loss)	0702	70M
CH	SCII w/Clip (5M SPC)	0802	80M
CI	SCII w/Clip (5M UPC)	0902	90M
CJ	SCII w/Clip (5M APC)	1002	100M
DF	LC w/Clip (MM)		
DG	LC w/Clip (MM Low Loss)		
DH	LC w/Clip (5M SPC)		
DI	LC w/Clip (5M UPC)		
DJ	LC w/Clip (5M APC)		

**Example:**

**LP-F57DDLCAADF0052** Fiber Optic Trunk Harness, OM3 50/125um, 36C, PCV end B pulling eye Aqua jacket, 12F MTP® MM to LC w/Clip MM, 5m length.

# 40G to 100G migration series MTP® & MPO LanPro Y cable

LanPro Y cable is typically to join two 12-fiber trunk cables to a 24-fiber patch cords as part of a migration to 100GbE. LanPro also supports the rather rare version of 1 to 3 allowing three 8-fiber.

## Applications:

Provide interconnect and cross-connect of migration from 40G to 100G.

## Specifications:

Support

- 1 x 24 MTP® /MPO = 2 x 12 MTP® /MPO
- 1 x 24 MTP® /MPO = 3 x 8 MTP® /MPO
- 2 x 12 MTP® /MPO = 3 x 8 MTP® /MPO

- OM1 (62.5/125 um): for LED-based propagation
- OM2 (50/125UM): for LED or laser-based propagation
- OM3 & OM4 (50/125um): for VCSEL-based propagation
- OS1/OS2 (9/125um): Laser-based propagation.

## Fiber Compatibility:

OM1, OM2, OM3, OM4, OS1/OS2.

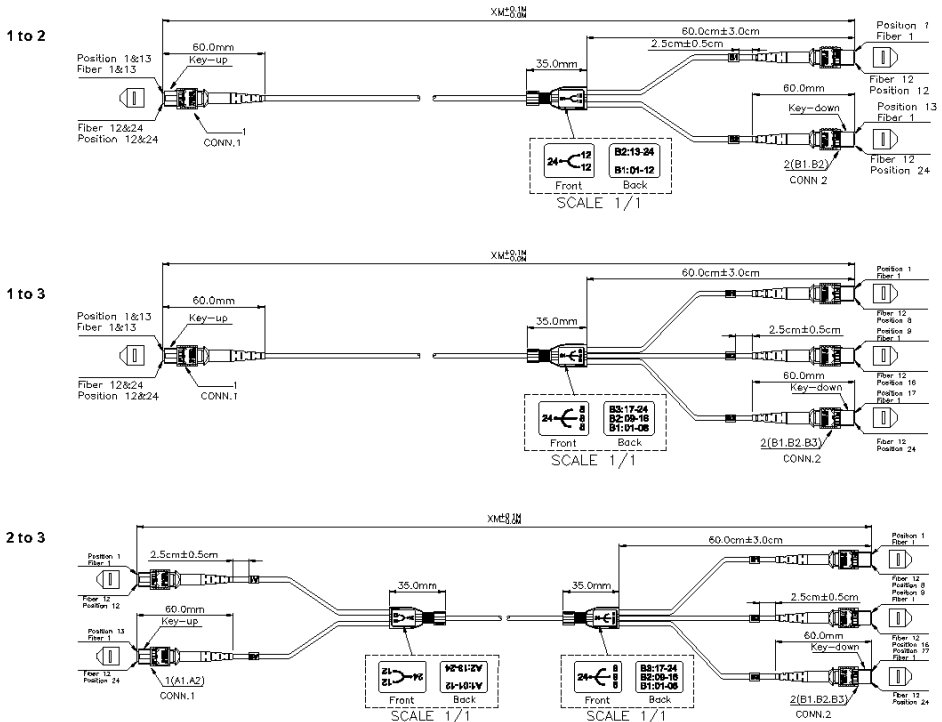

# Order Information

**LP-F60 D I L I CA KA 0022**

LP-F60	FIBER TYPE	BREAKOUT CABLE TYPE	COLOR	JACKET MATERIAL	A CONECTOR			
LANPRO Y CABLE	C	10G 50/125um	I	24C-Round Cable, 3.0mm Jacket	A BL	A PVC	CA	24 F MTP* (MM)
	D	OM3 50/125			B OR	E PVC OFNP	CB	24 F MTP* (MM Low Loss)
	E	OM4 50/125			C GN	I LSZH	CC	24 F MTP* (5M APC)
	F	5M(G652D) 9/125um			D BR		CD	24 F MTP* (5M APC Low Loss)
	H	5M(G657A2) 9/125um			E GY		CE	24 F MTP*+Guide Pin (MM)
					F WH		CF	24 F MTP*+Guide Pin (MM Low Loss)
					G RD		CG	24 MTP*+Guide Pin (5M APC)
					H BK		CH	24 F MTP*+Guide Pin (5M APC Low Loss)
				I YL		DA	24 F MPO (MM)	
				J VT(PU)		DB	24 F MPO (MM Low Loss)	
				K RS(PK)		DC	24 F MPO (5M APC)	
				L AQ		DD	24 F MPO (5M APC Low Loss)	
						DE	24 F MPO+Guide Pin (MM)	
						DF	24 F MPO+Guide Pin (MM Low Loss)	
						DG	24 F MPO+Guide Pin (5M APC)	
						DH	24 F MPO+Guide (5M APC Low Loss)	

**Example:**

**LP-F60DILICAKA0022** Fiber Optic Y Cable, OM3 50/125, 24C-Round Cable, 3.0mm Aqua LSZH Jacket, 24F MTP® (MM) to 8F MTP® (MM), 2m length.

## Order Information

**LP-F60 D I L I C A K A 0022**

B CONECTOR		LENGTH	
KA	8 F MTP* (MM)	0022	2m
KB	8 F MTP* (MM Low Loss)	0032	3m
KC	8 F MTP* (SM APC)	0052	5m
KD	8F MTP* (SM APC Low Loss)	0102	10m
KE	8 F MTP*+Guide Pin (MM)	0152	15m
KF	8 F MTP*+Guide Pin (MM Low Loss)	0202	20m
KG	8 F MTP*+Guide Pin (SM APC)	0252	25m
KH	8 F MTP*+Guide Pin (SM APC Low Loss)		
KI	12 F MTP* (MM)		
KJ	12 F MTP* (MM Low Loss)		
KK	12 F MTP* (SM APC)		
KL	12 F MTP* (SM APC Low Loss)		
KM	12 F MTP*+Guide Pin (MM)		
KN	12 F MTP*+Guide Pin (MM Low Loss)		
KO	12 F MTP*+Guide Pin (SM APC)		
KP	12 F MTP*+Guide Pin (SM APC Low Loss)		
LA	8 F MPO (MM)		
LB	8 F MPO (MM Low Loss)		
LC	8 F MPO (SM APC)		
LD	8 F MPO (SM APC Low Loss)		
LE	8 F MPO+Guide Pin (MM)		
LF	8 F MPO+Guide Pin (MM Low Loss)		
LG	8 F MPO+Guide Pin (SM APC)		
LH	8 F MPO+Guide Pin (SM APC Low Loss)		
LI	12 F MPO (MM)		
LJ	12 F MPO (MM Low Loss)		
LK	12 F MPO (SM APC)		
LL	12 F MPO (SM APC Low Loss)		
LM	12 F MPO+Guide Pin (MM)		
LN	12 F MPO+Guide Pin (MM Low Loss)		
LO	12 F MPO+Guide Pin (SM APC)		
LP	12 F MPO+Guide Pin (SM APC Low Loss)		

**Example:**

**LP-F60DILICAKA0022** Fiber Optic Y Cable, OM3 50/125, 24C-Round Cable, 3.0mm Aqua LSZH Jacket, 24F MTP\* (MM) to 8F MTP\* (MM), 2m length.

# What is MTP®, MPO?



MPO stands for “multi-fiber push on”. It was developed by Nippon Telegraph and Telephone (NTT) in the early 90’s. MTP® is an MPO-style connector that is manufactured by US CONEC ([www.usconec.com](http://www.usconec.com)). The MTP® design and performance have made significant improvements over the standard MPO connector. A common misconception is that these are two different styles of connectors, in fact, they are the same footprint. The difference between MTP® and MPO can be found:

- MPO (Multi-fiber push-on), MTP® (Mechanical Transfer Push-on)
- MTP® design is an improved version of the MPO
- MTP® is patented and is a ruggedized version with elliptical shaped
- MTP® is with stainless alignment pin tips to improve insertion guidance and reduce guide hole wear
- MTP® also provides a ferrule float to improve mechanical performance by maintaining physical contact while under an applied load.

IEEE 802.3ba, the standard for implementing 40/100 Gb/s Ethernet, indicates that the MPO footprint be the standard for multimode transmission. This is a radical new transmission type called “parallel transmission”. This assures the MTP® and/or MPO connector will be the future of optical transmission in the data center for the next generations to come.



# ● FIBER CONNECTOR & ADAPTOR

LanPro provides a complete line of fiber connectors & adaptors, ST, SC, FC, LC, MTRJ, MTP® and MPO, for the flexibility to answer any factory termination need or others. Both singlemode and multimode are available. Each connector meets FOClS and TIA/EIA-568-C.3 standards and delivers pre-assembled from the factory to reduce installation time. Zirconia ferrules with pre-radius end faces allows for physical contact polishing supporting super or ultra PC performance (SPC or UPC).



## ST, SC, FC, LC, MTRJ, MTP®, MPO

**Table 1: Connector Performance**

Test & Standard Ref	ST			FC			SC			LC			MTRJ			MPO			
Intermateability Standard	TIA/EIA-604-2			TIA/EIA-604-4			TIA/EIA-604-3			TIA/EIA-604-10			TIA/EIA-604-12			TIA/EIA-604-5			
Stretch Test																			
IL & RL	Typical IL	Max IL	Max RL	Typical IL	Max IL	Max RL	Typical IL	Max IL	Max RL	Typical IL	Max IL	Max RL	Typical IL	Max IL	Max RL	Typical IL	Max IL	Max RL	
Singlemode (SPC)	≤0.15dB	≤0.2dB	≥45dB	≤0.15dB	≤0.2dB	≥45dB	≤0.15dB	≥0.2dB	≥45dB	≤0.15dB	≤0.2dB	≥45dB	≤0.2dB	≥45dB	≤0.2dB	≥45dB	N/A	N/A	N/A
Singlemode (UPC)	≤0.15 dB	≤0.2dB	≥55dB	≤0.15dB	≤0.2dB	≥55dB	≤0.15dB	≥0.2dB	≥55dB	≤0.15dB	≤0.2dB	≥55dB	≤0.15dB	≤0.2dB	≥55dB	≥0.3dB	N/A	≥45dB	
Singlemode (APC)	N/A	N/A	N/A	≤0.15dB	≤0.2dB	≥60dB	≤0.15dB	≥0.2dB	≥60dB	≤0.15dB	≤0.2dB	≥60dB	N/A	N/A	≥60dB	N/A	≥0.75dB	≥60dB	
Multimode Mode (PC)	≤0.25dB	≤0.3dB	N/A	≤0.25dB	≤0.3dB	N/A	≤0.25dB	≤0.3dB	N/A	≤0.25dB	≤0.3dB	N/A	≤0.25dB	≤0.3dB	N/A	≥0.4dB	≤0.5dB	N/A	
Ferrule Ø / tolerance	SM: Ø125.5 ± 126.µm (±0.5µm) M MØ126.0 ± 127.5µm (±75µm)																		
Thermal age: GR-326-CORD 4.4.2.1.	85°C for 168 hours <0.2Db Change																		
Temperature Cycling: IEC 60603-7-4	-40°C to +70°C, 30min, 25 cycles <0.3dB Change																		
Damp Heat: IEC 60603-7-4	+65°C at 93% RH, 12 hours, +25°C at 93% RH, 10 Hours, -10°C, 2 hours, 21 cycles <0.25dB Change																		
Salt Spray Test: IEC 60068-2-11	Saline concentration: 5%, PH: 6.8±0.45, value of spray: 1.0–2.0ml/80cm <sup>2</sup> /h, Test hours: 8h; 24h; 48h; 72h; 96h																		
Mating Durability: TIA/EIA-435-21	Maximum insertion loss ≤0.3dB after 500 mating																		

**Table 2: Connector Performance**

Test & Standard Ref	ST			FC			SC			LC			MTRJ			MPO		
Intermateability Standard	TIA/EIA-604-2			TIA/EIA-604-4			TIA/EIA-604-3			TIA/EIA-604-10			TIA/EIA-604-12			TIA/EIA-604-5		
Stretch Test																		
Insertion force test PB sleeve	200–700gf			200–700gf			200–700gf			100–300gf			N/A			N/A		
Insertion force test Zirconia sleeve	200–600gf			200–600gf			200–600gf			100–250gf			N/A			N/A		
Insertion Loss (Multimode/Singlemode)	< 0.2dB / < 0.2dB			< 0.2dB / < 0.2dB			< 0.2dB / < 0.2dB			< 0.2dB / < 0.2dB			< 0.2dB / < 0.2dB			< 0.3dB / < 0.3dB		
Thermal age: GR-326-CORD 4.4.2.1.	85°C for 168 hours <0.2dB Change																	
Temperature Cycling: IEC 60603-7-4	-40°C to +70°C, 30min, 25 cycles <0.2dB Change																	
Damp Heat: IEC 60603-7-4	+65°C at 93% RH, 12 hours, +25°C at 93% RH, 10 hours, -10°C, 2 hours, 21 cycles <0.2dB Change																	
Salt Spray Test	Saline concentration: 5%, PH: 6.8±0.45, value of spray: 1.0–2.0 ml/80cm <sup>2</sup> /h, Test hours: 8h; 24h; 48h; 72h; 96h																	

## Specifications:

ST is compatible with TIA FOCIS-2 and field installable in one module space. The fibers terminate in 2.5mm ferrules and have typical insertion loss of 0.3dB (multimode) or 0.2dB (singlemode) per connector.

## Fiber Compatibility:

Multimode 62.5 / 125um, 50/125um  
Singlemode 9/125um

## Applications:

ST fiber optic connectors & adaptor are widely used in fiber optic backbone and horizontal applications for high speed data transmissions. Multimode connectors provide a low cost, easy to terminate solution for fiber-to-the-desk and horizontal applications. Singlemode provides ultimate data transmission capabilities.

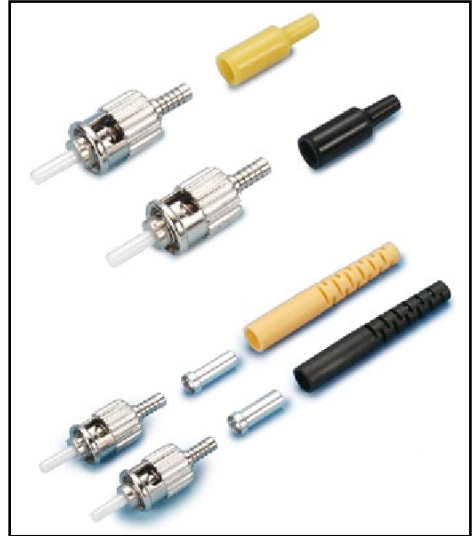

## Connector Order Information

Type	Mode	Polish	S/D	Boot Size (mm)	Boot Color	Code
ST	MM	PC	Simplex	0.9	Black	LP-F11A1219
ST	SM	SPC	Simplex	0.9	Yellow	LP-F11A3239
ST	MM	PC	Simplex	2.0	Black	LP-F11A1319
ST	SM	SPC	Simplex	2.0	Yellow	LP-F11A3339
ST	MM	PC	Simplex	3.0	Black	LP-F11A1119
ST	SM	SPC	Simplex	3.0	Yellow	LP-F11A3139



## Adaptor Order Information

Adaptor	Port	Type	Mode	Sleeve	Housing Color	Code
ST	Simplex	Thread	OM1, OM2, OM3, OM4	Phosphor Bronze	Metal	LP-F1501M14
ST	Simplex	Thread	OS1, OS2	Zr. Ceramic	Metal	LP-F1501S14
ST	Simplex	Flange	OM1, OM2, OM3, OM4	Phosphor Bronze	Ivory	LP-F1502M13
ST	Simplex	Flange	OS1, OS2	Zr. Ceramic	Blue	LP-F1502S11
ST	Duplex	Flange	OM1, OM2, OM3, OM4	Phosphor Bronze	Ivory	LP-F1503M13
ST	Duplex	Flange	OS1, OS2	Zr. Ceramic	Blue	LP-F1503S11

## Specifications:

LanPro's FC connector & adaptor are designed to NTT-FC standards, including FC Angled Physical Contact (APC). The pre-assembled, one-piece body design and pre-polished ferrules provide quick and economical terminations for in-factory and in-the-field setting. Besides, the pre-polished ferrule and LanPro termination method guarantees uniform endface geometry.

## Fiber Compatibility:

Multimode 62.5/125 um, 50/125um  
Singlemode 9/125um

## Applications:

FC is specifically approved for telecommunication applications, such as ATM testing, CATV, active device termination, FTTX, Fiber channel testing and optical switches.



## Connector Order Information

Type	Mode	Polish	S/D	Boot Size (mm)	Boot Color	Code
FC	MM	PC	Simplex	0.9	Black	LP-F11C1219
FC	SM	SPC	Simplex	0.9	Yellow	LP-F11C3239
FC	SM	APC	Simplex	0.9	Green	LP-F11S249
FC	MM	PC	Simplex	3.0	Black	LP-F11C1119
FC	SM	SPC	Simplex	3.0	Yellow	LP-F11C3139
FC	SM	APC	Simplex	3.0	Green	LP-F11S149



## Adaptor Order Information

Adaptor	Port	Type	Mode	Sleeve	Housing Color	Code
FC	Simplex	Square	OM1, OM2, OM3, OM4	Phosphor Bronze	Metal	LP-F1504M14
FC	Simplex	Square	OS1, OS2	Zr. Ceramic	Metal	LP-F1504S14
FC	Simplex	DType	OM1, OM2, OM3, OM4	Phosphor Bronze	Metal	LP-F1505M14
FC	Simplex	DType	OS1, OS2	Zr. Ceramic	Metal	LP-F1505S14
FC	Simplex	Flange	OM1, OM2, OM3, OM4	Phosphor Bronze	Ivory	LP-F1506M13
FC	Simplex	Flange	OS1, OS2	Zr. Ceramic	Blue	LP-F1506S11



## Specifications:

SC field polish connectors are compliant with TIA/EIA-604 FOCIS-3. Both simplex and duplex are field terminable. The fiber terminates in 2.5mm ceramic ferrules with non-optical disconnect functionality and an average insertion loss of 0.3dB (multimode) and 0.2dB (singlemode) per mated pair.

## Fiber Compatibility:

Multimode 62.5/125 um, 50/125um  
Singlemode 9/125um

## Applications:

SC connectors are used for equipment cross-connects or interconnects in backbone, horizontal, work area applications and data room. SC is the one, recommended by TIA/EIA-604 FOCIS-3. At the wall outlet and the telecommunication closet. Multimode supports a robust and rapid termination for lower cost fiber-to-the-desk applications. Singlemode connectors provide the flexible capacity.

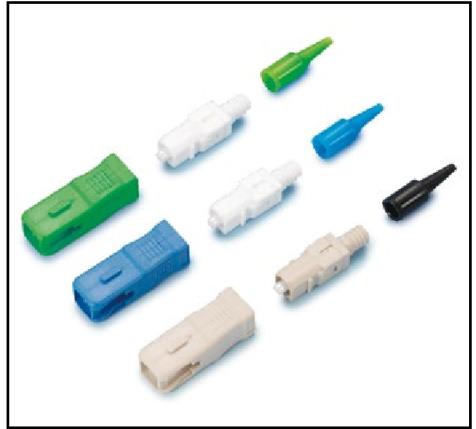

## Connector Order Information

Type	Mode	Polish	S/D	Boot Size (mm)	Boot Color	Code
SC	MM	PC	Simplex	0.9	Black	LP-F11F12166
SC	SM	SPC	Simplex	0.9	Blue	LP-F11F32555
SC	SM	APC	Simplex	0.9	Green	LP-F11J52448
SC	MM	PC	Simplex	3.0	Black	LP-F11F11166
SC	SM	SPC	Simplex	3.0	Blue	LP-F11F31558
SC	SM	APC	Simplex	3.0	Green	LP-F11J51448
SC	MM	PC	Duplex	3.0	Black&Red	LP-F11H11766
SC	SM	SPC	Duplex	3.0	Blue	LP-F11H31558
SC	SM	APC	Duplex	3.0	Green	LP-F11H51448



LanPro SC and LC adaptors simplex, duplex, with flange and flangeless type, are engineered to one piece type. This one piece housing feature prevents breaking of the adaptor due to the deficiency in ultrasonic process. The true one piece body optimizes side loading performance over conventional adaptors.

## Adaptor Order Information

Adaptor	Port	Type	Mode	Sleeve	Housing Color	Code
SC	Simplex	Flange	OM1, OM2	Phosphor Bronze	Ivory	LP-F1507M13
SC	Simplex	Flange	OM3, OM4	Zr. Ceramic	Aqua	LP-F1507M26
SC	Simplex	Flange	OM4	Zr. Ceramic	Violet	LP-F1507M27
SC	Simplex	Flange	OS1, OS2	Zr. Ceramic	Blue	LP-F1507S11
SC	Simplex	Flange	OS1, OS2	Zr. Ceramic	Green	LP-F1507S12
SC	Simplex	Flangeless	OM1, OM2	Phosphor Bronze	Ivory	LP-F1507M131
SC	Simplex	Flangeless	OM3, OM4	Zr. Ceramic	Aqua	LP-F1507M261
SC	Simplex	Flangeless	OM4	Zr. Ceramic	Violet	LP-F1507M271
SC	Simplex	Flangeless	OS1, OS2	Zr. Ceramic	Blue	LP-F1507S111
SC	Simplex	Flangeless	OS1, OS2	Zr. Ceramic	Green	LP-F1507S121
SC	Duplex	OM1, OM2	OM1, OM2	Phosphor Bronze	Ivory	LP-F1508M13
SC	Duplex	OM3, OM4	OM3, OM4	Zr. Ceramic	Aqua	LP-F1508M26
SC	Duplex	OM4	OM4	Zr. Ceramic	Violet	LP-F1508M27
SC	Duplex	OS1, OS2	OS1, OS2	Zr. Ceramic	Blue	LP-F1508S11
SC	Duplex	OS1, OS2	OS1, OS2	Zr. Ceramic	Green	LP-F1508S12
SC	Duplex	OM1, OM2	OM1, OM2	Phosphor Bronze	Ivory	LP-F1508M131
SC	Duplex	OM3, OM4	OM3, OM4	Zr. Ceramic	Aqua	LP-F1508M261
SC	Duplex	OM4	OM4	Zr. Ceramic	Violet	LP-F1508M271
SC	Duplex	OS1, OS2	OS1, OS2	Zr. Ceramic	Blue	LP-F1508S111
SC	Duplex	OS1, OS2	OS1, OS2	Zr. Ceramic	Green	LP-F1508S121

## Specifications:

LC is small form factor (SFF), compliant with TIA/EIA-604 FOCIS-10. The main drivers of SFF is cost and space saving for cabling, hardware and equipment interfaces. There are three industry standards colors, beige (multimode), blue (singlemode) and green (8° angle polish) colors and will accommodate 900um buffered fiber, 1.6 mm, 2.0 mm or 3.0 mm jacketed cable. With the particular six-position turning feature, the connector achieves unprecedented insertion loss performance by optimizing the alignment of the fiber cores.

## Fiber Compatibility:

Multimode 62.5/125 um, 50/125um  
Singlemode 9/125um

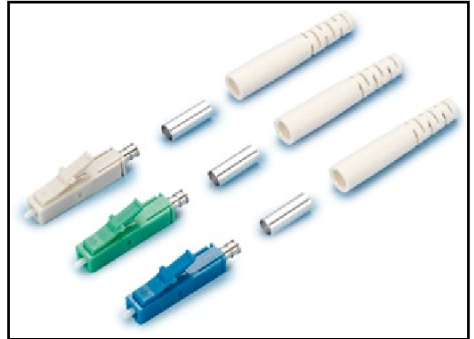

## Applications:

LC connectors can be used with iMC® series, patch panels, faceplates and surface mounted box. It also can support a rugged solution for LANs, public networks, storage area networks and fiber-to-the-desk applications. The particular 1.25mm ferrules double the port density (compared with SC) to increase space on racks and enclosures. LC is the ideal one to answer the high density in data centers.

## Connector Order Information

Type	Mode	Polish	S/D	Boot Size (mm)	Boot Color	Code
LC	MM	PC	Simplex	0.9	White	LP-F11L1286
LC	SM	SPC	Simplex	0.9	White	LP-F11L3285
LC	SM	APC	Simplex	0.9	White	LP-F11L5284
LC	MM	PC	Simplex	2.0	White	LP-F11L1386
LC	SM	SPC	Simplex	2.0	White	LP-F11L3385
LC	SM	APC	Simplex	2.0	White	LP-F11L5384
LC	MM	PC	Simplex	3.0	White	LP-F11L1186
LC	SM	SPC	Simplex	3.0	White	LP-F11L3185
LC	SM	APC	Simplex	3.0	White	LP-F11L5184

### Duplex LC adaptors with stainless clip for iMC® series

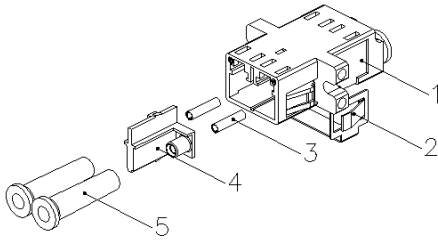

1. Housing : Polycarbonate, UL94V-0
2. Clip: Stainless
3. Split Sleeve: Zr.,PB
4. Holder : Polycarbonate, UL94v-0
5. Dust Cover: PP,White Color

### Duplex LC adaptors without stainless clip

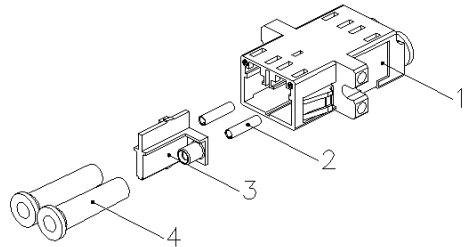

1. Housing : Polycarbonate, UL94V-0
2. Split Sleeve: Zr.,PB
3. Holder : Polycarbonate, UL94v-0
4. Dust Cover: PP,White Color

## Adaptor Order Information

Adaptor	Port	Type	Mode	Sleeve	Housing Color	Code
LC	Duplex	Flange	OM1, OM2	Phosphor Bronze	Ivory	LP-F1515M13
LC	Duplex	Flange	OM3, OM4	Zr. Ceramic	Aqua	LP-F1515M27
LC	Duplex	Flange	OM4	Zr. Ceramic	Violet	LP-F1515M27
LC	Duplex	Flange	OS1, OS2	Zr. Ceramic	Blue	LP-F1515S11
LC	Duplex	Flange	OS1, OS2	Zr. Ceramic	Green	LP-F1515S12
LC	Duplex	Flangeless	OM1, OM2	Phosphor Bronze	Ivory	LP-F1515M131
LC	Duplex	Flangeless	OM3, OM4	Zr. Ceramic	Aqua	LP-F1515M261
LC	Duplex	Flangeless	OM4	Zr. Ceramic	Violet	LP-F1515M271
LC	Duplex	Flangeless	OS1, OS2	Zr. Ceramic	Blue	LP-F1515S111
LC	Duplex	Flangeless	OS1, OS2	Zr. Ceramic	Green	LP-F1515S121

## Adaptor Order Information

Adaptor	Port	Type	Mode	Sleeve	Housing Color	Code
LC	Quad	Flange	OM1, OM2	Phosphor Bronze	Ivory	LP-F1514M13
LC	Quad	Flange	OM3, OM4	Zr. Ceramic	Aqua	LP-F1514M26
LC	Quad	Flange	OM4	Zr. Ceramic	Violet	LP-F1514M27
LC	Quad	Flange	OS1, OS2	Zr. Ceramic	Blue	LP-F1514S11
LC	Quad	Flange	OS1, OS2	Zr. Ceramic	Green	LP-F1514S12
LC	Quad	Flangeless	OM1, OM2	Phosphor Bronze	Ivory	LP-F1514M131
LC	Quad	Flangeless	OM3, OM4	Zr. Ceramic	Aqua	LP-F1514M261
LC	Quad	Flangeless	OM4	Zr. Ceramic	Violet	LP-F1515M271
LC	Quad	Flangeless	OS1, OS2	Zr. Ceramic	Blue	LP-F1514S111
LC	Quad	Flangeless	OS1, OS2	Zr. Ceramic	Green	LP-F1514S121
LC	Duplex	Flange (w/metallic clip)	OM1, OM2	Phosphor Bronze	Ivory	LP-F1515M132
LC	Duplex	Flange (w/metallic clip)	OS1, OS2	Zr. Ceramic	Blue	LP-F1515S112
LC	Duplex	Flangeless (w/metallic clip)	OM1, OM2	Phosphor Bronze	Ivory	LP-F1515M133
LC	Duplex	Flangeless (w/metallic clip)	OS1, OS2	Zr. Ceramic	Blue	LP-F1515S113

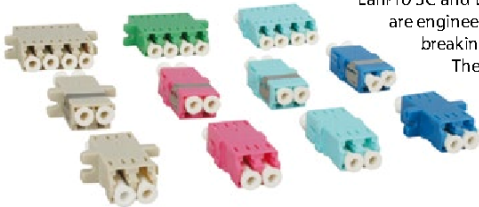

LanPro SC and LC adaptors simplex, duplex, with flange and flangeless type, are engineered to one piece type. This one piece housing feature prevents breaking of the adaptor due to the deficiency in ultrasonic process. The true one piece body optimizes side loading performance over conventional adaptors.

## Specifications:

MTRJ stands for Mechanical Transfer Registered Jack and is also popular for small form factor devices on account of its small size. It utilizes two fibers and integrates them into a single design that looks similar to a RJ45 connector. Alignment is completed through the use of two pins that mate with the connector.

## Fiber Compatibility:

Multimode 62.5/125 um, 50/125um  
Singlemode 9/125um

## Applications:

MTRJ supports a rugged solution for LANs, public networks, storage area networks and fiber-to-the-desk applications. The particular 1.25mm ferrules double the port density (compared with SC) to increase space on racks and enclosures.

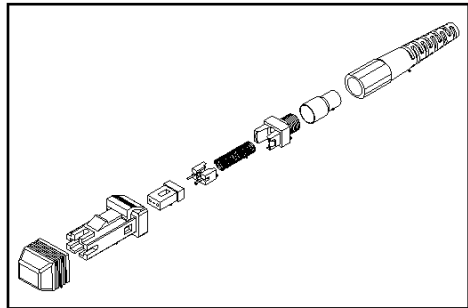

## Connector Order Information

Type	Mode	Polish	F/M	Boot Size (mm)	Boot Color	Code
MTRJ	MM	PC	Female	1.8	Black	LP-F11M1411
MTRJ	SM	SPC	Female	1.8	Black	LP-F11M3411
MTRJ	MM	PC	Male	1.8	Black	LP-F11N1411
MTRJ	SM	SPC	Male	1.8	Black	LP-F11N3411
MTRJ	MM	PC	Female	3.0	Black	LP-F11M1111
MTRJ	SM	SPC	Female	3.0	Black	LP-F11M3111
MTRJ	MM	PC	Male	3.0	Black	LP-F11N1111
MTRJ	SM	SPC	Male	3.0	Black	LP-F11N3111



## Adaptor Order Information

Type	Mode	Type	Mode	Sleeve	Housing Color	Code
MTRJ	Simplex	Flange	OM1, OM2, OM3, OM4	*	Black	LP-F1513M18
MTRJ	Simplex	Flange	OM1, OM2, OM3, OM4	*	Gray	LP-F1513M19

## Specifications:

MPO connectors with push-pull latching are available with 4, 8, 12 or fibers color-housings differentiate singlemode (green) and multimode (beige). Manufactured to IEC standard 1754-7 and TIA/EIA 604-5. MTP® is the patented MPO, owing to US Conec. Both MTP® and MPO are available.

## Fiber Compatibility:

Multimode 62.5/125 um, 50/125um  
Singlemode 9/125um

## Applications:

MPO supports a rugged solution for LANs, public networks and storage area networks. The particular MT ferrules increase the port density (compared with SC,LC) on racks and enclosures. MPO is the ideal and a exclusive one to answer the high density in 10G, 40G and 100G data centers.



## Connector Order Information

Type	Fiber	Mode	Polish	F/M	Boot Size (mm)	Boot Color	Housing Color	Code
MPO	12	MM	PC	Female	3.0	Black	Aqua	LP-F4061113
MPO	12	SM	APC	Female	3.0	Black	Green	LP-F4065111
MPO	12	MM	PC	Male	3.0	Black	Aqua	LP-F4051113
MPO	12	SM	APC	Male	3.0	Black	Green	LP-F4055111
MPO	24	MM	PC	Female	3.6	Black	Aqua	LP-F4081213
MPO	24	SM	APC	Female	3.6	Black	Green	LP-F4085211
MPO	24	MM	PC	Male	3.6	Black	Aqua	LP-F4071213
MPO	24	SM	APC	Male	3.6	Black	Green	LP-F4075211
MTP®	12	MM	PC	Female	3.0	Black	Aqua	LP-F40F1113
MTP®	12	SM	APC	Female	3.0	Black	Green	LP-F40F5111
MTP®	12	MM	PC	Male	3.0	Black	Aqua	LP-F40E1113
MTP®	12	SM	APC	Male	3.0	Black	Green	LP-F40E5111
MTP®	24	MM	PC	Female	3.6	Black	Aqua	LP-F40H1213
MTP®	24	SM	APC	Female	3.6	Black	Green	LP-F40H5211
MTP®	24	MM	PC	Male	3.6	Black	Aqua	LP-F40G1213
MTP®	24	SM	APC	Male	3.6	Black	Green	LP-F40G5211

# MTP® / MPO TYPE

Type	Part	A/B	Type	Mode	Housing Material	Housing color	Code
MPO	Simplex	A (up to down)	Flange	OM3, OM4, OS1, OS2	PBT + 15%	Black	LP-F4101111
MPO	Simplex	B (up to up)	Flange	OM3, OM4, OS1, OS2	PBT + 15%	Black	LP-F4102111
MPO	Simplex	A (up to down)	Flangeless	OM3, OM4, OS1, OS2	PBT + 15%	Black	LP-F41011111
MPO	Simplex	B (up to up)	Flangeless	OM3, OM4, OS1, OS2	PBT + 15%	Black	LP-F41021111
MPO	Simplex	A (up to down)	Flange (SC Footprint)	OM3, OM4, OS1, OS2	PBT + 15%	Black	LP-F41011113
MPO	Simplex	B (up to up)	Flange (SC Footprint)	OM3, OM4, OS1, OS2	PBT + 15%	Black	LP-F41021113
MPO	Simplex	A (up to down)	Flangeless (SC Footprint)	OM3, OM4, OS1, OS2	PBT + 15%	Black	LP-F41011114
MPO	Simplex	B (up to up)	Flangeless (SC Footprint)	OM3, OM4, OS1, OS2	PBT + 15%	Black	LP-F41021114
MTP®	Simplex	A (up to down)	Flange	OM3, OM4, OS1, OS2	Polyetherimide	Black	LP-F4103112
MTP®	Simplex	B (up to up)	Flange	OM3, OM4, OS1, OS2	Polyetherimide	Gray	LP-F4104122



**A type: with 2 white dot**



**B type: with 1 white dot**



## Adaptor Order Information

Adaptador	Port	Type	Mode	Sleeve	Housing Color	Code
ST to FC	Simplex	Flange	OM1, OM2, OM3, OM4	Phosphor Bronze	Ivory	LP-F1509M13
ST to FC	Simplex	Flange	OS1, OS2	Zr. Ceramic	Blue	LP-F1509S11
ST to SC	Simplex	Flange	OM1, OM2, OM3, OM4	Phosphor Bronze	Ivory	LP-F1510M13
ST to SC	Simplex	Flange	OS1, OS2	Zr. Ceramic	Blue	LP-F1510S11
SC to FC	Simplex	Flange	OM1, OM2, OM3, OM4	Phosphor Bronze	Ivory	LP-F1511M13
SC to FC	Simplex	Flange	OS1, OS2	Zr. Ceramic	Blue	LP-F1511S11
SC to ST	Duplex	Flange	OM1, OM2, OM3, OM4	Phosphor Bronze	Ivory	LP-F1512M13
SC to ST	Duplex	Flange	OS1, OS2	Zr. Ceramic	Blue	LP-F1512S11



## Applications:

iMC® Series offers one flexible connectivity for workstation cabling termination on singlemode and multimode fiber cable and easily snaps into any housing with LanPro's flush and surface mount outlets, box and configuration panels.

## Fiber Compatibility:

Multimode 62.5/125 um, 50/125um  
Singlemode 9/125um

## Design Considerations:

- ST, FC, SC and LC are available in phosphor bronze and zirconia ceramic sleeves
- Convenient to use in permanent or temporary applications
- iMC® series snap into panels, surface mounted box and flush outlets
- SC is available in blue for identification in singlemode applications



Adaptador	Port	Type	Mode	Sleeve	Housing Color
ST	Simplex	Thread	OM1, OM2, OM3, OM4	Phosphor Bronze	Metal
ST	Simplex	Thread	OS1, OS2	Zr. Ceramic	Metal
SC	Simplex	Flange	OM1, OM2, OM3, OM4	Phosphor Bronze	Ivory
SC	Simplex	Flange	OS1, OS2	Zr. Ceramic	Blue
SC to ST	Simplex	Flange	OM1, OM2, OM3, OM4	Phosphor Bronze	Ivory
SC to ST	Simplex	Flange	OS1, OS2	Zr. Ceramic	Blue
SC to ST	Simplex	Flange	OM1, OM2, OM3, OM4	Phosphor Bronze	Ivory
SC to ST	Simplex	Flange	OS1, OS2	Zr. Ceramic	Blue
MTRJ	Simplex	Flange	OM1, OM2, OM3, OM4	*	Ivory
LC	Duplex	Flange	OM1, OM2, OM3, OM4	Phosphor Bronze	Ivory
LC	Duplex	Flange	OS1, OS2	Zr. Ceramic	Blue
LC	Duplex	Flangeless	OM1, OM2, OM3, OM4	Phosphor Bronze	Ivory
LC	Duplex	Flangeless	OS1, OS2	Zr. Ceramic	Blue
FC	Simplex	D Type	OM1, OM2, OM3, OM4	Phosphor Bronze	Metal
FC	Simplex	D Type	OS1, OS2	Zr. Ceramic	Metal

## Order Information

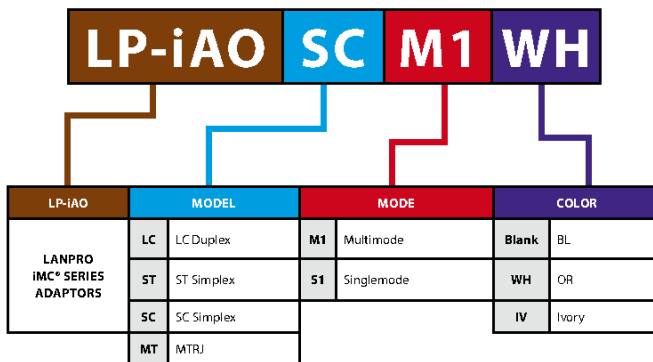

**Example:**

LP-iAOSCM1WH iMC® Series Adaptor, SC Simplex, Multimode, white color body.

# What is Fiber Optic Insertion Loss?

Insertion loss (IL) is the amount of light lost (it is measured in dB) from the origination of a signal to the reception of that same signal. What happens if insertion loss is too high? Too high of an insertion loss will lead to what is known as “channel errors” that can cause equipment to go down and possibly cause data center downtime. Is insertion loss important? Sure, knowing the insertion loss before you purchase, ask for insertion loss specifications and pay attention to the words like “typical” versus “maximum” insertion loss.

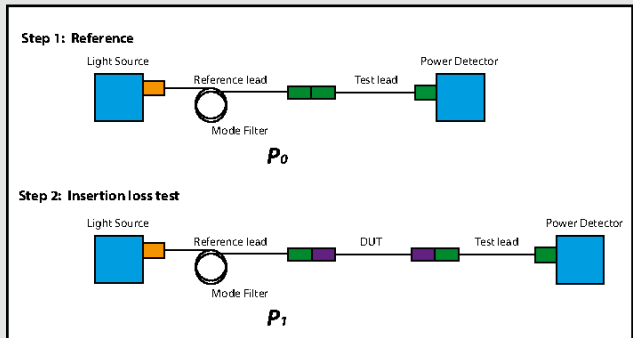
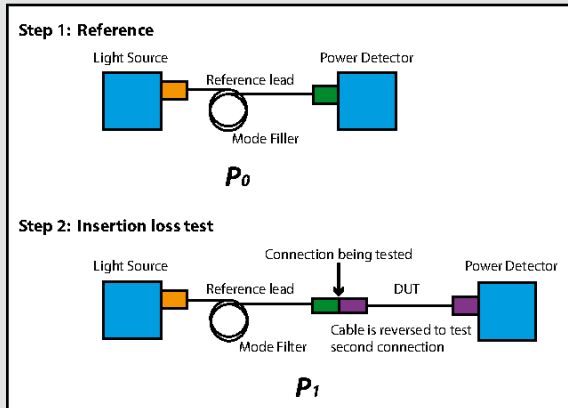

## Specifications:

The FusionLess® Optical Mechanical Connector by LanPro is a pre-polished, pre-assembled mechanical connector compatible with the standard SC connector.

In place of epoxy, an internal mechanical grip gently but effectively holds the fiber in place and can be installed in under two minutes. Without polishing or adhesives, the FusionLess® Optical Connector makes installations quick and easy, eliminating the need for epoxy curing and hand polishing at the work site.

The FusionLess® Optical Mechanical Connector comes with an assembling jig and fiber holder, making for an accurate alignment and fiber cleave when terminating the connector.



## FusionLess®

## Applications:

- Low insertion loss mechanical connector, equivalent to fusion technology.
- Reusable, a unique feature not found in similar designs.
- Fast installation in less than 2 minutes per point.
- Special tools needed are a fraction of the cost of those needed in fusion technology.
- Telcordia approved.
- No epoxy. No polishing.
- Pre-assembled.
- All tools available from LanPro.
- Excellent performance versus price ratio.
- 15 years life in operation.
- Reusable up to 3 times.
- Made in Japan under strict quality procedures.

Specification	Singlemode (Typical)	Multimode
Insertion Loss	0.2 dB (PC) and 0.3 dB (APC)	0.1 dB
Return Loss	-55 dB (PC), -60 dB (APC)	-35 dB
Durability	< 0.1 dB change, 500 matings	
Operating Temperature	-40°C to +75°C	
Tensile	TIA/EIA 568-B.3	
Intermateability	IEC 61754-4	

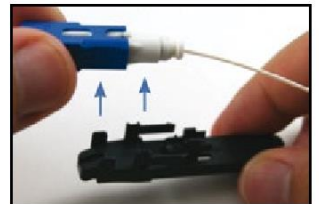
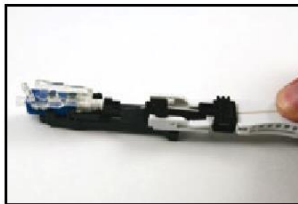

## Order Information

LP-FL	TYPE	FIBER MODE AND TYPE		FIBER CABLE DIAMETER		COLOR HOUSING		COLOR BOOT	
LANPRO FUSION LESS	SC	M1	Multimode OM1 IEC 60793-2-10 Type A1b 62.5/125µm	1	0.9 mm	1	Blue	1	White
		M2	Multimode OM2 IEC 60793-2-10 Type A1a.1 50/125µm	2	0.25 mm	2	Green		
	LC	M3	Multimode OM3 IEC 60793-2-10 Type A1a.2 50/125µm	3	Both 0.9 mm and 0.25 mm	3	Black		
		M4	Multimode OM4 IEC 60793-2-10 Type A1a.3 50/125µm	4	2.0 mm	4	Beige		
		S1	Singlemode ITU-T G.652.D Type B1.3 9/125µm	5	3.0 mm	5	Aqua		

### Example:

**LP-FLSCS1311** FusionLess® Connector, SC, Singlemode, PC Polish, ITU-T G.652.D Type B1.3 9/125µm, Fiber cable diameter both 0.9mm and 0.25 mm, Blue Housing, White boot.

LanPro understands that the ultimate goal in Data Center networks is to have zero downtime or extreme network availability. The strict schedule constrains and budgets, demanding reliability and performance without compromise is a must. LanPro's 5S (Safety +, Speed +, Space +, Saving +, Service +) delivers fast-deployment, with built-in reliability combined with guaranteed performance and headroom.

## Save Time & Money

- No testing or troubleshooting required
- Up to 90% reduction in installation time and labor cost
- Fast delivery to meet short project turn-around deadlines

## Easy Plug & Play

- Easy to order: simplified ordering process eliminates errors
- Easy to install immediately
- Easy to configure: a complete range to choose from to build a system

## Easy Plug & Play

- Easy to order: simplified ordering process eliminates errors
- Easy to install immediately
- Easy to configure: a complete range to choose from to build a system

## Make it "Green"

- Small, flexible and efficient cable assembly design mean less cable to be deployed and no unnecessary slack
- Up to 50% material reduction in Data Center cabling topology
- All system components can be easily re-deployed and reused.

Complexity in the data center increases expense and risk, so for new technology deployments to meet business requirements they must be simple to manage, maintain and make provision. Infrastructure reliability, performance, flexibility and availability are essential, and trade-off of one for the other are no longer accepted.

Deploying a modular, high-density, MTP®/MPO-based structure wired cabling system in the data center will significantly increase response to data center moves, adds and changes (MACs). LanPro provides one complete range of

MTP®/MPO products: adaptors, connectors, array cable, trunk cable, distribution cable, direct harness, harness and trunk harness. Here, it is meant to provide you with an introduction to the practical application of MTP®/MPO technology. It shows the migration approach via 10 Gigabit to 40/100 Gigabit.

- **Components: adaptor, cable types and modules**
- **Method A, B, C**
- **Migration: from 10GbE to 100GbE**

## Adaptor

There are two types of MPO adaptors, according to the placement of the key:

**Type A:** Key-up to Key-down = the key is up on one side and the other is down. The two connector are connected turned 180°.

**Type B:** Key-up to Key-up = the key is up at both sides.

When making an MTP®/MPO connection, use one male connector and female connector plus one MTP®/MPO adaptor. MTP®/MPO, with guide pins, is called male (refer to the following photo, right side, with guide pin). Don't connect a male to a male or a female to a female. Their guide pins hit against pins so it damages the connector.

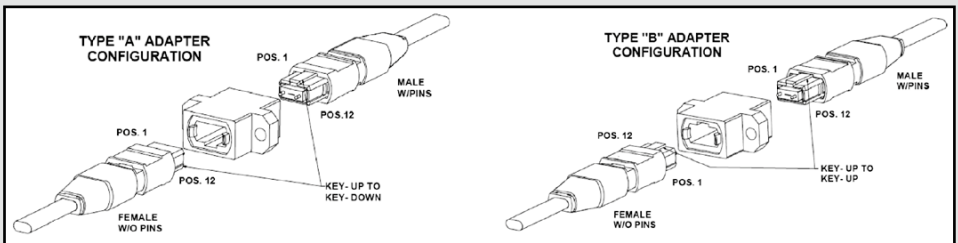

# Cables

LanPro supports 11 series for fiber patch cords, including array cord, direct harness, harness, trunk harness, trunk, distribution cable and mini Breakout. These are delivered with pre-termination at factory. The following illustrates the straight-through version (A-to-B), A-to-A is for cross-over version.

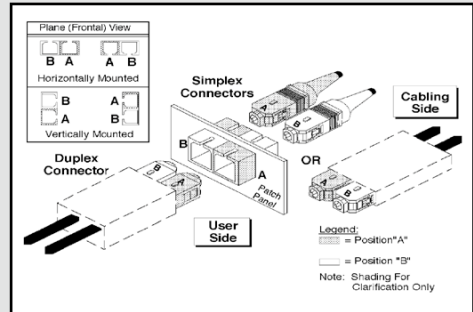
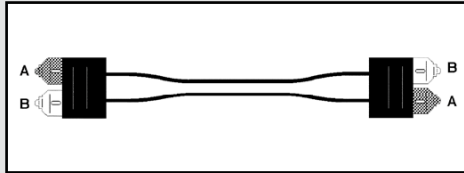

## Cassette Module & Adapter plate

The cassette modules and adapter plates are what connect the permanent link to the patch cable. The MTP®/ MPO module enables the user to take the fibers brought by a trunk cable and distribute them to a duplex cable. Because the cassette is already assembled with direct harness cable inside, it is fitted with 12 or 24 fibers and has LC or SC adaptors on the front side and MTP®/MPO at the rear side. The adaptor plate connects the MTP®/MPO trunk cable with one MTP®/MPO patch cord or harness cable. The adaptor plates are available with 6 MTP®/MPO adaptors, type A or type B.

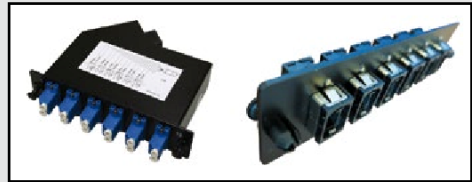

## The Polarity Methods

TIA-568-C defines three polarity, A, B, C. The main purpose is to guarantee the right bi-directional allocation.

**Method A:** use type A MTP®/MPO adaptor (key-up to key-down) and straight-through backbones. This method is easy, saving time and money. Just one cassette type is needed. It is the most popular method, widely deployed in data center.

**Method B:** use type B MTP®/MPO adaptor (key-up to key-up). Singlemode cannot be used in method B and it is necessary to prepare two types for cassette modules. Compared with method A, method B requires more planning effort and expense.

**Method C:** use type A MTP®/MPO adaptor (key-up to key-down). A straight-through patch cord (A-to-B) is used on both ends of the link. The pair-wise flip of polarity occurs in the backbone, which absolutely increases effort to plan. This is not very widespread either because of the greater effort. It doesn't offer a way of migrating to 40/100GbE, in other words, method C increases expense.



MTP®/MPO Cable Type A: Key-up to key-down			MTP®/MPO Cable Type B: Key-up to key-down			MTP®/MPO Cable Type C: Key-up to key-down		
Fibers		Fibers	Fibers		Fibers	Fibers		Fibers
1		1	1		1	1		1
2		2	2		2	2		2
3		3	3		3	3		3
4	Key-up	4	4	Key-up	4	4	Key-up	4
5	ITEM 1	5	5	Key-down	5	5	ITEM 1	5
6		6	6		6	6		6
7		7	7		7	7		7
8	ITEM 12	8	8	ITEM 12	8	8	ITEM 12	8
9		9	9		9	9		9
10		10	10		10	10		10
11		11	11		11	11		11
12		12	12		12	12		12

TIA Connectivity Method	Patch Cord Type one end of the link	MTP®/MPO adaptor type at the back of cassette	Array Cable-to-cassette keying	Array Cable Type	MTP®/MPO adaptor type at the back of cassette	Array Cable-to-cassette keying	Patch Cord Type at one end of the link
Method A	A-to-B	A	Key up to Key down	A	A	Key up to Key down	A-to-A
Method B	A-to-B	B	Key up to Key down	B	B	Key up to Key up	A-to-B
Method C	A-to-B	A	Key up to Key down	C	A	Key up to Key down	A-to-B

## The Polarity Methods

In data center, the capacity expansion is usually carried out in three steps:

- Increase capacity in existing 10G environment
- From 10G to 40G
- From 40G to 100G

Expansion in 10G	A-to-B patch cord (LC or SC)	+	Cassette (Type A)	MTP®/MPO array cord 12 core (Type A)	+	Cassette (Type A)	+	A-to-A patch cord (LC or SC)
	A-to-B patch cord (LC or SC)	+	Cassette (Type A)	MTP®/MPO array cord 12 core (Type A)	+	MTP®/MPO adaptor plate (Type A)	+	Harness/Trunk Harness (MTP®/MPO to LC/SC)
	A-to-B patch cord (LC or SC)	+	Cassette (Type A)	*	+	*	+	Harness/Trunk Harness (MTP®/MPO to LC/SC)

<b>10G to 40G</b>	MTP®/MPO array cord 12 core (Type A) + MTP®/MPO adaptor plate (Type A) + MTP®/MPO array cord 12 core (Type A) + MTP®/MPO adaptor plate (Type A) + MTP®/MPO array cord 12 core (Type B)
	MTP®/MPO array cord 12 core (Type B) + MTP®/MPO adaptor plate (Type B) + MTP®/MPO array cord 12 core (Type B) + MTP®/MPO adaptor plate (Type B) + MTP®/MPO array cord 12 core (Type B)
<b>40G to 100G</b>	MTP®/MPO Trunk (Type A, 2 x 12 core in one MTP®/MPO 24 core) + MTP®/MPO adaptor plate (Type A) + MTP®/MPO array cord 12 core (Type A) x 2 pcs + MTP®/MPO Trunk (Type B, 2 x 12 core in one MTP®/MPO 24 core)
	MTP®/MPO Trunk 24 core (Type A) + MTP®/MPO adaptor plate (Type A) + MTP®/MPO adaptor plate (Type A) + MTP®/MPO Trunk 24 core (Type B)
	MTP®/MPO Trunk (Type B, 2 x 12 core in one MTP®/MPO 24 core) + MTP®/MPO adaptor plate (Type B) + MTP®/MPO adaptor plate (Type B) + MTP®/MPO Trunk (Type B, 2 x 12 core in one MTP®/MPO 24 core)
	MTP®/MPO Trunk 24 core (Type B) + MTP®/MPO adaptor plate (Type B) + MTP®/MPO adaptor plate (Type B) + MTP®/MPO Trunk 24 core (Type B)

## OM3 & OM4

Why OM3 & OM4 is widely deployed in data center? Statistics show that among the backbone optical fiber links in data centers, 88% are shorter than 100 meters 94% are shorter than 125 meters and 100% are shorter than 300 meters. Basically 100 meters is enough. IEEE ultimately adopted OM4 as it is capable of transmitting 40/100Gb/s over 150m and thereby supports over 97% of all links in data center.

Application	OM1		OM2		OM3		OM4		OS1/OS2	
Wavelength	850	1,300	850	1,300	850	1,300	850	1,300	1,310	1,550
FDDI PMD		2000		2000		2000		2000		
FDDI SMF-PMD									10,000	
10/100Base-SX	300		300		300		300			
100Base-FX		2000		2000		2000		2000		
1000Base-SX	275		550		800		800			
1000Base-LX		550		550		800		800	5000	
10GBase-S	33		82		300		550			
10GBase-LX4		300		300		300		300	10,000	
10GBase-L									10,000	
10GBase-LRM		220		220		220		220		
10GBase-E										40,000
40GBase-SR4					100		150			
40GBase-LR4									10,000	
100GBase-SR10					100		150			
100GBase-LR4									10,000	
100GBase-ER4										30,000

# Low Loss

Total connector loss within a system channel impacts the ability of a system to operate over the maximum supportable distance for a give date rate. The 40/100G Ethernet standard specifies the OM3 fiber 100M distance maximum channel loss to be 1.9dB (a 1.5dB total connector loss is included). The OM4 fiber 150M distance maximum channel loss is 1.5dB, which includes a 1.0dB total connector loss budget. With low-loss MTP®/MPO connectivity components, maximum flexibility can be obtained with the ability to introduce multiple connector mating into the connectivity link.

## Fiber Pre-Terminated Cabling Performance (dB)

LanPro recommends using pre-terminated trunks and harness whenever and wherever possible. With 100% factory testing and no need for field terminations or splices, installation time and cost are reduced by up to 50%

Connector Mated Pairs	MULTIMODE (OM3 & OM4)						Singlemode (OS1, OS2)		
	Duplex Typical IL	Duplex Max IL	Duplex Max IL (Low-Loss)	12-fiber Standard Typical IL	12-fiber Standard Max IL	12-fiber Standard Max IL (Low-Loss)	Typical IL	Max IL	Low Loss Max IL
LC	0.15	0.50	0.15	-	-	-	0.25	0.30	0.15
SC	0.20	0.50	0.15	-	-	-	0.25	0.30	0.15
MTP®/MPO	-	-	-	0.40	0.50	0.35	0.30	0.75	0.35

MTP®/MPO Modules & Harness	MULTIMODE (OM3 & OM4)			Singlemode (OS1, OS2)		
	12-fiber Standard Typical IL	12-fiber Standard Max IL	12-fiber Standard Low Max IL	Typical IL	Max IL	Low Loss Max IL
LC	-	0.50	0.50	0.50	0.50	0.50
SC	-	0.50	0.50	0.50	0.50	0.50
MTP®/MPO	0.40	0.50	0.35	0.60	0.75	0.35

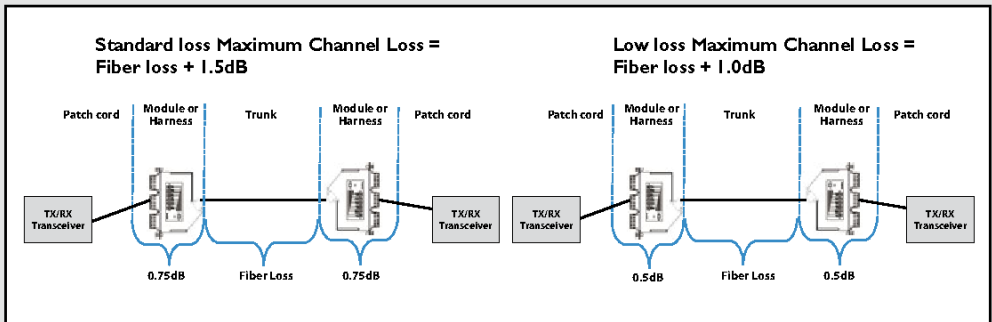

# How to calculate Insertion Loss?

When you start to calculate the maximum distance for an optical link, consider tables 1 and 2:

Table 1

For Wavelength: 1310nm	Attenuation Km (dB/Km)	Attenuation/Optical connector (dB)	Attenuation/join (Db)	
MIN	0.30	0.40	0.02	Best Conditions
Average	0.38	0.60	0.10	Normal
MAX	0.50	1.00	0.20	Worst

Table 2

For Wavelength: 1550nm	Attenuation Km (dB/Km)	Attenuation/Optical connector (dB)	Attenuation/join (Db)	
MIN	0.17	0.20	0.01	Best Conditions
Average	0.22	0.35	0.05	Normal
MAX	0.40	0.70	0.10	Worst

Total Attenuation (TA) =  $n \times C + c \times J + L \times a + M$

- **n**- number of connectors
- **C**- attenuation for one optical connector (dB)
- **c**- number of splices in elementary cable section
- **J**- attenuation for one splice (dB)
- **L**- total length of the optical cable
- **a**- attenuation for optical cable (dB/Km)
- **M**- system margin (patch cord, cable bend, unpredictable optical attenuation events, and so on, should be considerate around 3dB)

When you apply this formula to the example, and assume certain values for the optical cards, you obtain these results:

For wavelength 1310nm:

Normal  $TA = n \times C + c \times J + L \times a + M = 2 \times 0.6dB + 4 \times 0.1dB + 20.5Km \times 0.38dB/Km + 3dB = 12.39dB$

For wavelength 1310nm:Worst Situation  $TA = n \times C + c \times J + L \times a + M = 2 \times 1dB + 4 \times 0.2dB + 20.5Km \times 0.5dB/Km + 3dB = 16.05dB$ .

For wavelength 1550nm: Normal  $TA = n \times C + c \times J + L \times a + M = 2 \times 0.35dB + 4 \times 0.05dB + 20.5Km \times 0.22dB/Km + 3dB = 8.41dB$

For wavelength 1550nm:Worst Situation  $TA = n \times C + c \times J + L \times a + M = 2 \times 0.7dB + 4 \times 0.1dB + 20.5Km \times 0.4dB/Km + 3dB = 13dB$

Assume that the optical card has these specifications:

$Tx = -3dB$  to  $0dB$  at 1310nm  $Rx = -20dB$  to  $-27dB$  at 1310nm In this case, the power budget is between 27 dB and 17 dB.

If you consider the worst card, which has the power budget at 17 db at 1310nm, and the worst situation for the optical link to be 16.05dB at 1310nm, you can estimate that your optical link will work without any problem. In order to be sure of this, you must measure the link.

# Pigtail & Patchcord

Test & Standard Ref	ST			FC			SC			LC			MTRJ			MPO		
Intermateability Standard	TIA/EIA-604-2			TIA/EIA-604-4			TIA/EIA-604-3			TIA/EIA-604-10			TIA/EIA-604-12			TIA/EIA-604-5		
Stretch Test																		
IL & RL	Typical IL	Max IL	Max RL	Typical IL	Max IL	Max RL	Typical IL	Max IL	Max RL	Typical IL	Max IL	Max RL	Typical IL	Max IL	Max RL	Typical IL	Max IL	Max RL
Singlemode (SFC)	≤0.15dB	≤0.2dB	≥45dB	≤0.15dB	≤0.2dB	≥45dB	≤0.15dB	≤0.2dB	≥45dB	≤0.15dB	≤0.2dB	≥45dB	≤0.15dB	≤0.2dB	≥45dB	≤0.35dB	0.75dB	≥45dB
Singlemode (UPC)	≤0.15 dB	≤0.2dB	≥55dB	≤0.15dB	≤0.2dB	≥55dB	≤0.15dB	≤0.2dB	≥55dB	≤0.15dB	≤0.2dB	≥55dB	≤0.15dB	≤0.2dB	≥55dB	≤0.35dB	0.75dB	≥55dB
Singlemode (APC)	N/A	N/A	N/A	≤0.15dB	≤0.2dB	≥60dB	≤0.15dB	≤0.2dB	≥60dB	≤0.15dB	≤0.2dB	≥60dB	N/A	N/A	N/A	≤0.35dB	≤0.75dB	≥60dB
Multimode Mode (PC)	≤0.25dB	≤0.3dB	N/A	≤0.25dB	≤0.3dB	N/A	≤0.25dB	≤0.3dB	N/A	≤0.25dB	≤0.3dB	N/A	≤0.25dB	≤0.30dB	N/A	≤0.4dB	≤0.75dB	N/A
<b>3D Interferometer</b>																		
APC Polish Angle	8°(APC) ±0.3°																	
Ferrule ROC	PC Polosh: Ø 2.5mm 10<R0<25mm, Ø1.25mm 7<R<25mm (PC), 5<R<12mm (APC)																	
Apex Offset	PC: <50um																	
Protrusion	PC: <50nm,APC: <100nm																	
Undercut	PC: <50nm,APC: <100nm																	
MT Ferrule	12C									24C								
	Multimode			Singlemode APC			Multimode			Singlemode APC								
X Radius of Curvature (mm)	MM: > 1000			APC: > 1000			MM: > 1000			APC: > 1000								
Y Radius of Curvature (mm)	MM: > 100			APC: > 100			MM: > 100			APC: > 100								
X Endface Ang (degree)	MM: -0.2°~0.2°			APC: -0.2°~0.2°			MM: -0.2°~0.2°			APC: -0.2°~0.2°								
Y Endface Ang (degree)	MM: -0.2°~0.2°			SM: 7.7°~8.3°			MM: -0.2°~0.2°			SM: 7.7°~8.3°								
Flatness Deviation (um)	MM: -0.5~0.5			APC: -0.5~0.5			MM: -0.5~0.5			APC: -0.5~0.5								
Max Difference Height Total (um)	MM: 0~0.3			APC: 0~0.3			MM: 0~0.3			APC: 0~0.3								
Planar Difference Height Total (um)	MM: 0~1.0			APC: 0~1.0			MM: 0~1.0			APC: 0~1.0								
Fiber Protrusion (um)	MM: 1.0~3.0			APC: 1.0~3.0			MM: 1.0~3.0			APC: 1.0~3.0								
Fiber Core Dip (um)	MM: -0.10~0.1			SM: -0.1~0.10			MM: -0.30~0.3			SM: -0.3~0.30								

# ● OPTICAL DISTRIBUTION FRAMES (ODF), WALL ENCLOSURES AND PATCH PANELS

## 12 Port, Optical Distribution Frame (ODF). Unloaded

The 12 port Optical Distribution Frame (ODF) is designed as a reliable fiber optic organization and distribution product, it is of the sliding type, convenient for operations and maintenance. The 12 port ODF has wide operation temperature range and made for high density fiber optic installations.

### Specifications:

- Dust covers: PVC.
- Chassis (Matrix): 1.2mm thickness SPCC.
- Splice tray: 1 Set ABS+ PC UL 94V-0.
- Panel: 1.2mm Thickness SPCC.
- 6 places for 130 x 29 mm adaptor panels.
- Paint: Black Painted.
- Weight: 3.2 Kg.
- Dimensions: 1.75" x 19" x 11"(44.5 x 480.4 x 280 mm).
- Plastic Lock: 2 pieces ABS UL 94-HB.
- Environment temperature: -40°C ~+80°C.
- Relative humidity: ≤85% (30°C).
- Atmospheric pressure: 70~106KPa.
- Insulation Resistance: ≥2×10MΩ/500V (DC).
- Voltage withstand capability ≤ 15kv (DC) /1min  
no spark-over and no flying arc.
- Fiber bending radium guaranteed: ≥40mm.
- Application: to terminate and distribute optical fiber cables, they are convenient in order to organize and connect fiber optic links.
- It can appropriately protect fiber connectors.

### Applications:

- The chassis is made of hardened steel & insulation materials, thus having excellent mechanical and electrical performance, it is a solid and durable equipment.
- Number of Adapters output: 12 ports (Not included).
- Holds up to two 130x29mm adapter holding panels.
- Strength member core clamp and shell insulated and with grounding lead.

### Classic Style ODF

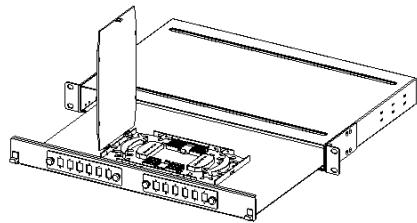

Dimension : 1.75" x 19" x 11"

Apply with adaptor panel size : 130 x 29 mm, pitch 116 mm

- SC, FC, ST or LC adaptors panels available in separate order as unloaded or loaded.
- 12 cores maximum Capacity.
- Reliable fiber lead grounding and perfect fix up.
- Reliable pigtail enclosure for protection and organization.
- For extensive field applications.
- Convenient for operation and its maintenance.

# 24 Port, Optical Distribution Frame (ODF). Loaded

## Classic Style ODF

The 24 port Optical Distribution Frame (ODF) is designed as a reliable fiber optic organization and distribution product, it is of the sliding type, convenient for operations and maintenance. The 24 port ODF has wide operation temperature range and made for high density fiber optic installations.

### Specifications:

- The chassis is made of hardened steel & insulation materials, thus having excellent mechanical and electrical performance, it is a solid and durable equipment.
- Number of Adapters output: 24 ports.
- Strength member core clamp and shell insulated and with grounding lead.
- Comes with factory loaded SC, FC, ST or LC adaptors.
- Excellent design.
- 24 cores maximum Capacity.
- Reliable fiber lead grounding and perfect fix up.
- Reliable pigtail enclosure for protection and organization.
- For extensive field applications.
- Convenient for operation and its maintenance.

### Applications:

- 24 Port factory installed as ordered.
- Dust covers: 2, PVC.
- Chassis (Matrix): 1.2 mm Thickness, SPCC.
- Splice tray: 2 sets, ABS+PC, UL 94V-0.
- Panel: 1.2mm thickness SPCC.
- Plastic Lock: 2 sets ABS.
- Dimensions: 1.75" x 19" x 11" (44.5 mm x 480.4 mm x 280 mm)
- Weight: 3.3. Kg
- Finish: black painted
- Environment temperature: -40°C ~+80°C.
- Relative humidity: ≤85% (30°C).
- Atmospheric pressure: 70~106KPa.
- Insulation Resistance: ≥2x10MΩ/500V (DC).
- Fiber bending radium guaranteed: ≥40mm.
- It can appropriately protect fiber connectors.

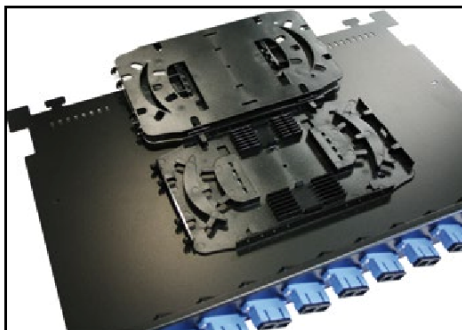

# 36 Port, Optical Distribution Frame (ODF). Loaded

## Classic Style ODF

The 36 port Optical Distribution Frame (ODF) is designed as a reliable fiber optic organization and distribution product, it is of the sliding type, convenient for operations and maintenance. The 36 port ODF has wide operation temperature range and made for high density fiber optic installations.

### Specifications:

- Dust covers: PVC.
- Chassis(Matrix): 1.2 mm thickness SPCC.
- Splice tray: 3 Sets ABS+PC UL 94V-0.
- Panel: 1.2 mm Thickness SPCC.
- 6 places for 99 x 37 mm adaptor panels.
- Paint: Black Painted.
- Weight: 4.1 Kg.
- Dimensions: 3.4" x 19" x 11" (89.7 x 480.4 x 280 mm).
- Plastic Lock: 2 pieces ABS UL 94-HB.
- Environment temperature: -40°C ~ +80°C.
- Relative humidity: ≤85% (30°C).
- Atmospheric pressure: 70~106KPa.
- Insulation Resistance: ≥2×10MΩ/500V (DC).
- Voltage withstand capability ≤ 15kv (DC) /1min no spark-over and no flying arc.
- Fiber bending radius guaranteed: ≥40mm.
- Application: to terminate and distribute optical fiber cables, they are convenient in order to organize and connect fiber optic links.
- It can appropriately protect fiber connectors.

### Applications:

- The chassis is made of hardened steel & insulation materials, thus having excellent mechanical and electrical performance, it is a solid and durable equipment.
- Number of Adapter ports (Not included): 36 ports.
- Holds up to six (6) 99 x 37 mm adaptor panels.
- Strength member core clamp and shell insulated and with grounding lead.
- SC, FC, ST or LC adaptors panels available in separate order as unloaded or loaded.
- Reliable fiber lead grounding and perfect fix up.
- Reliable pigtail enclosure for protection and organization.
- For extensive field applications.
- Convenient for operation and its maintenance.

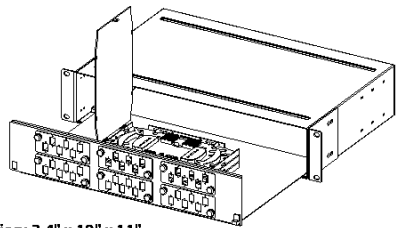
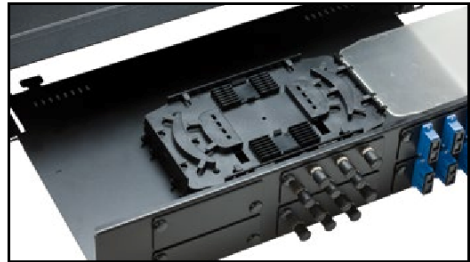

Dimension: 3.4" x 19" x 11"

Apply with adaptor panel size: 99 x 37 mm, pitch 87 mm



Dimension: 3.4" x 19" x 11"

Apply with adaptor panel size: 160 x 25.5 mm, pitch 146 mm



# 48 Port, Optical Distribution Frame (ODF). Loaded

## Classic Style ODF

The 48 port Optical Distribution Frame (ODF) is designed as a reliable fiber optic organization and distribution product, it is of the sliding type, convenient for operations and maintenance. The 48 port ODF has wide operation temperature range and made for high density fiber optic installations.

No panels included, the user can buy them separately in order to configure it as per the design needs.

### Specifications:

- Dust covers: PVC
- Chassis(Matrix): 1.2 mm thickness SPCC
- Splice tray: 4 Sets ABS+PC UL 94V-0
- Panel: 1.2 mm Thickness SPCC
- 6 places for 160 x 25.5 mm adaptor panels
- Paint: Black Painted
- Weight: 4.2 Kg
- Dimensions: 3.4" x 19" x 11" (89.7 x 480.4 x 280 mm)
- Plastic Lock: 2 pieces ABS UL 94-HB
- Environment temperature: -40°C ~+80°C.
- Relative humidity: ≤85% (30°C).
- Atmospheric pressure: 70~106KPa.
- Insulation Resistance: ≥2x10MΩ/500V (DC).
- Voltage withstand capability ≤ 15kv (DC)/1min no spark-over and no flying arc.
- Fiber bending radius guaranteed: ≥40mm.
- Application: Fiber distribution for terminating and distributing fiber optic cables in an organized and convenient way.
- Duct and direct buried.
- It can appropriately protect fiber connectors.

### Applications:

- The chassis is made of hardened steel & insulation materials, thus having excellent mechanical and electrical performance, it is a solid and durable equipment.
- Number of Adapter ports (Not included): 48 ports.
- Holds up to six (6) 160 x 25.5 mm adaptor panels.
- Strength member core clamp and shell insulated and with grounding lead.
- SC, FC, ST or LC adaptors panels available in separate order as unloaded or loaded.
- Reliable fiber lead grounding and perfect fix up.
- Reliable pigtail enclosure for protection and organization.
- For extensive field applications.
- Convenient for fiber distribution, its operation and maintenance.

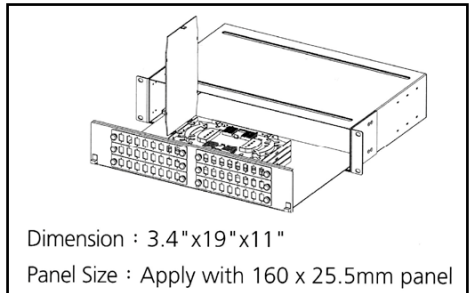

# 12 or 24 Port, Wall Mounted Optical Distribution Frame (ODF). Unloaded

*Classic Style ODF*

The 12 or 24 port Wall Mounted Optical Distribution Frame (ODF) unloaded and black painted, is designed as a reliable fiber optic organization and distribution product, is of the enclosure with two doors type, convenient for distribution operations and maintenance of fiber optics.

The 12 and 24 port ODF has wide operation temperature range and made for high density fiber optic installations. The user can decide which and how many adaptors to install by separately purchasing the 130 x 29 mm panels loaded with his / her choice of adaptors.

## Specifications:

- Dust covers: Qty.: 3. PVC
- Matrix (Chassis): SPCC, 1.2mm thickness
- Cover: 1.0mm thickness SPCC
- Lock: 1 piece metal with circular key
- Panel for mounting adaptor panels: 1.5mm Thickness SPCC
- 4 eMTP®y places for 130 x 29 mm adaptor panels
- Splice tray: 2 Set Aluminum
- Spool Cable routing: ABS, UL 94V-0, 2 sets
- Fiber bending radius guaranteed:  $\geq 40$ mm
- Paint: Black Painted
- Dimensions: 3.2" x 13.8" x 14.5" (81.5 mm x 350 mm x 370 mm)
- Weight: 4.0 Kg
- Environment temperature:  $-40^{\circ}\text{C} \sim +80^{\circ}\text{C}$ .
- Relative humidity:  $\leq 85\%$  ( $30^{\circ}\text{C}$ ).
- Atmospheric pressure: 70~106KPa.
- Insulation Resistance:  $\geq 2 \times 10\text{M}\Omega/500\text{V}$  (DC).
- Application: to terminate and distribute optical fiber cables, they are convenient in order to organize and connect fiber optic links.
- It can appropriately protect fiber connectors.

## Applications:

- The chassis is made of hardened steel & insulation materials, thus having excellent mechanical and electrical performance. It is a solid and durable equipment.
- Two door key-locked.
- Number of Adapters outputs (Not included): 12 or 24 ports.
- Holds up to four 130 x 29mm 6 port adapter holding panels.
- Lateral access openings for conduit entrance.
- SC, FC, ST, LC, etc., adaptor panels available in separate order as unloaded or loaded.
- 24 cores maximum Capacity.
- Reliable pigtail enclosure for protection and organization.
- For extensive field applications in optical fiber distribution.
- Convenient for its operation and maintenance.



These wall enclosures come without Modules for you to fill and configure with a variety of Fiber Optic Adaptor Modules

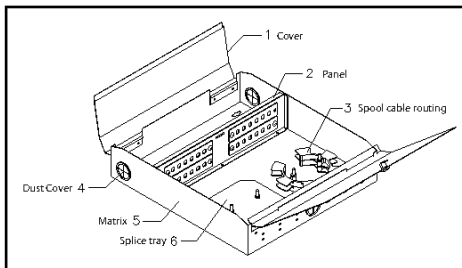

**12 and 24 Port Unit**  
364mm \* 350mm \* 81mm (14.5x13.8x3.2 inches)

# 36 or 48 Port, Wall Mounted Optical Distribution Frame (ODF). Unloaded

*Classic Style ODF*

The 36 or 48 port Wall Mounted Optical Distribution Frame (ODF) without adaptors is designed as a reliable fiber optic organization and distribution product, it is of the enclosure with doors type, convenient for operations and maintenance. The 36 or 48 port ODF has wide operation temperature range and is made for high density distribution in fiber optic installations.

The user can decide which and how many adaptors to install by separately purchasing the 99 x 37 mm panels loaded with his / her choice of adaptors.

## Specifications:

- Dust covers: Qty.: 3. PVC.
- Matrix (Chassis): SPCC, 1.2mm thickness.
- Cover: 1.0mm thickness SPCC.
- Lock: 1 piece metal with circular key.
- Panel for mounting adaptor panels: 1.5mm Thickness SPCC.
- 8 eMTP®y places for 99x37 mm adaptor panels.
- Splice tray: 4 Set Aluminum.
- Spool Cable routing: ABS, UL 94V-0, 4 sets.
- Fiber bending radius guaranteed:  $\geq 40\text{mm}$  Dust covers: PVC.
- Paint: Black Painted
- Dimensions: 4.4" x 13.8" x 14.5" (111.5 mm x 350 mm x 370 mm).
- Weight: 5 Kg
- Environment temperature:  $-40^{\circ}\text{C} \sim +80^{\circ}\text{C}$ .
- Relative humidity:  $\leq 85\%$  (30°C).
- Atmospheric pressure: 70~106KPa.
- Insulation Resistance:  $\geq 2 \times 10^{10}\text{M}\Omega/500\text{V}$  (DC).
- Application: to terminate and distribute optical fiber cables, they are convenient in order to organize and connect fiber optic links.
- It can appropriately protect fiber connectors.

## Applications:

- The chassis is made of hardened steel & insulation materials, thus having excellent mechanical and electrical performance. It is a solid and durable equipment.
- Dual door with keylock, circular type.
- Number of Adapters outputs (Not included): 36 or 48 ports.
- Holds up to eight (8) 99x37mm six(6) port adapter holding panels(Not included).
- Lateral opening for conduit access of optical cable.
- Panels for SC, FC, ST, LC, etc. adaptors, available in separate order as unloaded or loaded.
- 48 Fiber cores maximum capacity.
- Reliable pigtail enclosure for protection and organization.
- For extensive field applications.
- Convenient for its operation and maintenance.



These wall enclosures come without Modules for you to fill and configure with a variety of Fiber Optic Adaptor Modules

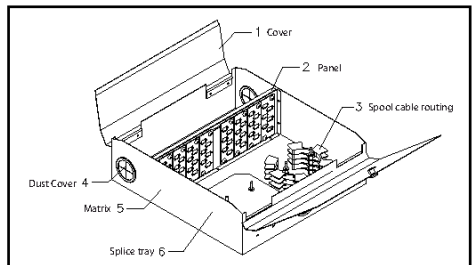

**36 and 48 Port Unit**  
364mm \* 350mm \* 112mm (14.5x13.8x4.4 inches)

# Order Information

LP-F		FIBER OPTIC WALL CABINET (BOX) OR PATCH PANEL LOADED OR UNLOADED	BOX/PANEL TYPE	PORTS	BOX/PANEL COLOR	COLOR BOOT	SLEEVE TYPE					
LANPRO FIBER OPTIC	18	Fiber Optic Wall Cabinet (Box) or Patch Panel Unloaded	1	Fiber Optic Wall Mounting Cabinet (Box)	A	12 Ports	IV	Ivory	00	Without adaptors	M1	Multimode Phosphor Bronze Sleeve
	19	Fiber Optic Wall Cabinet (Box) or Patch Panel Loaded	4	Patch Panel Rack mounted	B	24 Ports	BK	Black	01	ST Thread Type	51	Singlemode Zirconia Sleeve
					C	36 Ports	GR	Gray	02	ST Thread Type	Blank: Don't care	
					D	48 Ports	WH	White	03	ST Duplex Type		
					E	12 and 24 Ports			04	FC/PC Metal Square Type		
					F	36 and 48 Ports			05	FC/PC Metal D Type		
									06	FC/PC Flange Type		
								07	SC Simplex Type			
								08	SC Duplex Type			
								09	ST to FC Hybrid Type			
								10	ST to SC Hybrid Type			
								11	FC to SC Hybrid Type			
								12	ST to SC Duplex Type			
								13	MTRJ Type			
								14	LC Duplex Square Type			
								15	LC Simplex Type			
								16	LC Duplex Footprint Type			
								18	LC Duplex Footprint Type			
								19	SC Duplex Flangeless Type			
								20	SC Quad Flangeless Type			
								XX	Mixed Adaptor Type			
								YY	Without adaptors plate			
									Blank Don't care			

**Example:**  
**LP-F181EBKYY** 12 & 24 Port empty Fiber Optic Wall Enclosure without panels.

# Adaptor Panel Loaded (for Classic Style ODF)

Optical Fiber Wall Enclosures (Boxes) and Rack Mounted Patch Panels use Fiber Adaptor Panel Modules that can be loaded or unloaded with adaptors. A choice of Optical Fiber Adaptor Modules for panel mounting are manufactured by LanPro with stringent specifications in order to comply with the demanding standards of today.



## Order Information

**LP-F17 01 B BK M1 X**

LP-F17	ADAPTOR TYPE	PANEL & SIZE	PANEL COLOR	SLEEVE TYPE	ADAPTOR COLOR					
LanPro Adaptor Loaded Type	01	ST Thread	A	4 Ports 130x29mm	IV	Ivory	M1	Multimode Phosphor Bronze Sleeve	1	Blue Used for SM
	02	ST Flange	B	6 Ports 130x29mm	BK	Blak	S1	Singlemode Zirconia Sleeve	2	Green Used for SM APC Polish
	03	ST Duplex	C	2x3 Ports 99x37mm					3	IVORY used for MM
	04	FC Square							4	Black Used for MM
	05	FC D Type							X	Metal Used for MM and SM
	06	FC Flange								
	07	SC Simplex								
	08	SC Duplex								
	09	ST to FC								
	10	ST to SC Simplex								
	11	FC to SC								
	12	ST to SC Duplex								
	13	MTRJ								
	14	LC Duplex Square Type								
	15	LC Simplex								
	16	LC Duplex Footprint type								
	18	SC Flangeless								
	19	SC Duplex Flangeless								

### Example:

**LP-F1701BBKM1X** Fiber Optic Adaptor Loaded Type, ST Thread, 6 ports 130x29mm, Black color panel, multimode with Phosphor Bronze Sleeves and metal adaptor.

# Adaptor Panel Unloaded

(for Classic Style ODF)

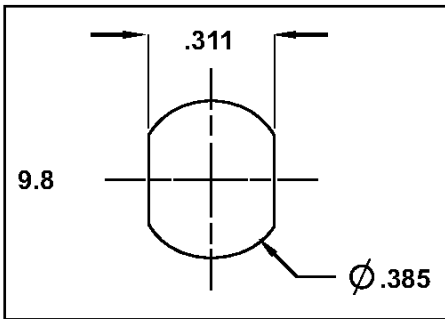
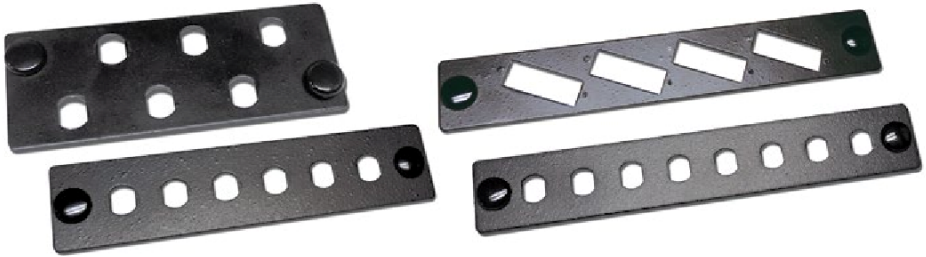

01: STThread

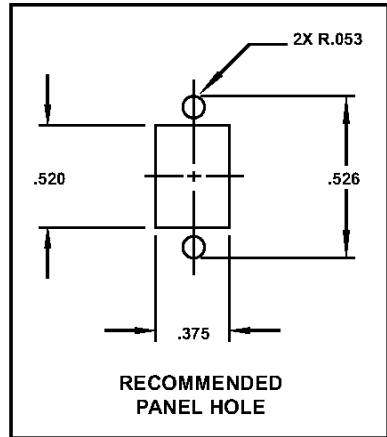

02: FC Flange, ST Flange, SC Simplex

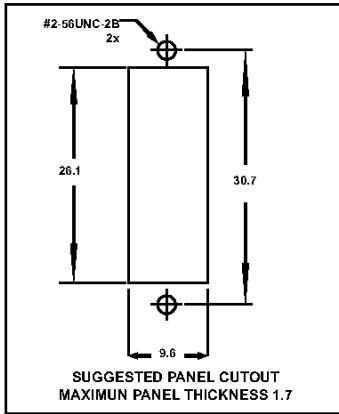

03: ST, SC Duplex, ST to SC Duplex

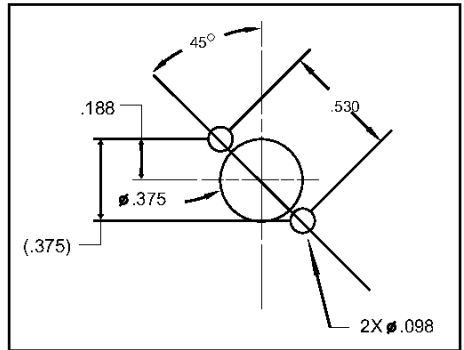

04: FC Square, FC D Type

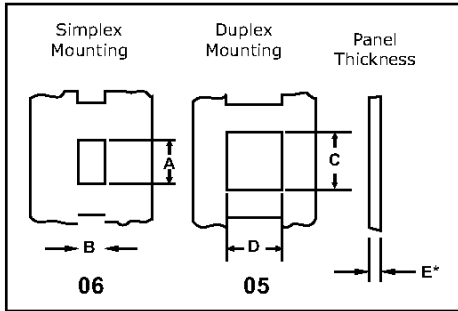

05 and 06: LC Duplex Square Type LC Simplex

2.3 - Panel Cutout Dimensions for Mounting LC Adapters		
Dimension	Minimum (mm)	Maximum (mm)
A	11.7	11.8
B	7.1	7.2
C	13.2	13.4
D	13.2	13.4
E*	1.2	1.7

\*Panel Thickness "E" applies after surface preparation i.e. painting, etc.

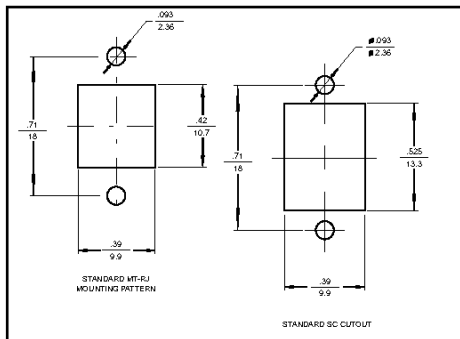

07: LC Duplex SC Footprint/MTRJ

# Order Information

**LP-F16 01 A BK**

LP-F16	HOLE TYPE		DUMMY PANEL & SIZE		COLOR	
LANPRO ADAPTOR UNLOADED TYPE	01	ST Thread	A	4 Ports 130 x 29 mm	IV	Ivory
	02	ST Flange	B	6 Ports 130 x 29 mm	BK	Black
	03	ST Duplex	C	2 x 3 Ports 99 x 37 mm		
	04	FC Square	D	8 Ports 160 x 25.5 mm		
	04	FC D Type				
	02	FC Flange				
	02	SC Simplex				
	03	SC Duplex				
	05	LC Duplex Square Type				
	06	LC Simplex				
	07	LC Duplex (SC Footprint)				
	07	MTRJ				
	02	ST to FC				
	02	ST to SC Simplex				
	02	FC to SC				
	03	ST to SC Duplex				
	XX	XX: Dummy				

**Example:**

**LP-F1601ABK** Fiber Optic Adaptor Unloaded Type, ST Thread Hole, 4 ports 130x29mm, Black color panel.



# Fiber Enclosure

Uni  
FIBER™

The Optical Distribution Frame (ODF) Model UniFiber™ is designed as a reliable fiber optic organization and distribution product, it is of the sliding type, convenient for operations and maintenance. This ODF has wide operation temperature range and made for high density fiber optic installations.

## Specifications:

- Number of Adapter ports (Not included): depending on adaptor plates used.
- Dust covers: PVC.
- Paint: Ivory Painted (Standard)
- Rear metallic door to help on maintenance and similar chores.
- Strength member core clamp and shell insulated and with grounding lead.
- SC, FC, ST or LC adaptors panels available in separate order as unload or loaded.

## Applications:

- The chassis is made of hardened steel & insulation materials, thus having excellent mechanical and electrical performance; it is solid and durable equipment.
- Heavy duty rack mount. No plastic. No aluminum. No weakness whatsoever. Thick metal plate of 1.5mm to handle heavy cables and abuse.
- Uses the same size adapter Interchangeable plates of 130 x 30 mm.
- A Fiber shelf is mounted over rolling bearings. Easy to pull out and get back in place. Thousands of times. Effortlessly.
- Attractive Ivory color, the Standard color for this kind of equipment.
- Several lateral as well as up/down openings to provide options to customers to feed the cable inside the unit.
- All metal edges protected to avoid cutting and/or abrasion.
- Front polycarbonate clear door, to keep dust and particles outside the unit.
- Recessed design. Once the lid is closed is almost impossible to damage the cables accidentally.
- Good organizer capability. Several anchor points for Tie-Wraps.



# Fiber Enclosure

UniFIBER™



## Order Information

**LP-F185 1 IV**

LP-F185	HEIGHT		BOX COLOR	
LANPRO (ODF) UNIFIBER™ TYPE	1	1U	IV	12 Ports
	2	2U	BK	16 Ports
	3	3U	GR	24 Ports
	4	4U	WH	36 Ports

**Example:**

**LP-F1851IV** Optical Distribution Frame (ODF) UniFiber™ type, 1U Height, Ivory color without panels.

# Adaptor Panel Loaded (for UniFiber™ ODF)

**Uni**FIBER™

These adaptor panels are meant to be used for patching fiber optic cable to the termination UniFiber™ (ODF). They snap in easily into the UniFiber™ (ODF) and enable you to make quick and easy fiber patch panel connections.

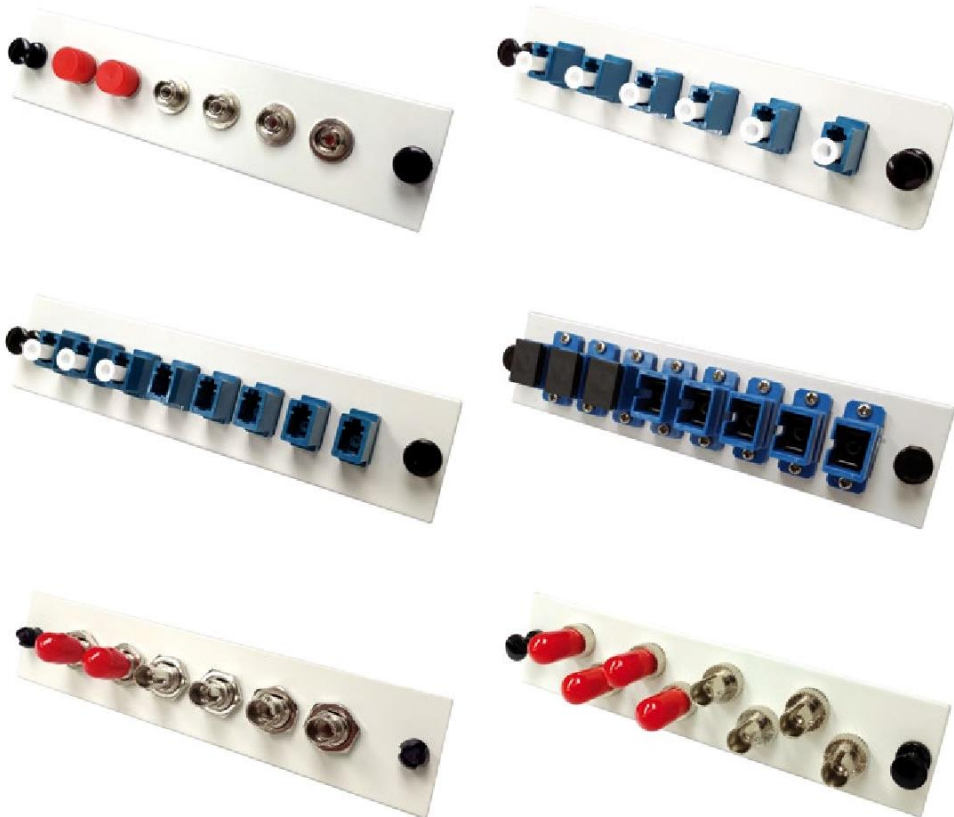

# Order Information

**LP-UA FC S 08 MM1 BK**

LP-UA	HOLE TYPE	ADAPTER TYPE	CORES	SLEEVE TYPE		COLOR				
LANPRO UNIFIBER™ ADAPTOR PLATE	00	No hole	0	No Adaptor	00	Blank Plate	APC	Zirconia Singlemode adaptor type	Blank	Ivory color
	5C	5C Adapter hole	5	Simplex	06	6 Cores	UPC	Zirconia Singlemode adaptor type	BK	Black
	LC	LC Adapter hole	D	Duplex	08	8 Cores	MM1	Bronze Multimode OM1/OM2 adaptor type	GR	Gray
	ST	ST Adapter hole	Q	Quad	12	12 Cores	MM2	Zirconia Multimode OM3/OM4 adaptor type		
	FC	FC Adapter hole			24	24 Cores				

**Example:**

**LP-UAFC S08MM1BK** Fiber Optic UniFiber™ Adaptor Plate, FC Simplex, 8 cores, Multimode OM1, Black color plate.

# • OPTICAL DISTRIBUTION FRAMES (ODF) FOR MTP®/MPO CASSETTES

This series is designed to increase flexibility for any environment in data center. Stylish and innovative design is ideal for today's most advanced networks and setting. One-piece removable panel face supports both cassette and flush-mount adaptor bulkhead for easy of moves, adds and changes. Accepts 3pcs x LGX cassette or 5pcs High Density cassette. The maximum capacity is 120pcs x LC (one HD cassette: 24pcs x LC, 24pcs x 5 = 120pcs). Optional cable management trays help route and organize cables on enclosures. Because the trays can be mounted directly to the front of the enclosures, they do not require additional rack space. With the convertible ears, this panel facilities the recessed depth, up to 60mm. Sliding tray glides 45 degree forward (with stop) and backward, and removes for easy field terminations and splicing, assist you future-proof your networks.

## Specifications:

- Compliant with EIA 19" cabinet
- Sliding tray with front and rear stop glides forward and backward providing accessibility to front and rear of bulkhead after installation
- Convertible ear support recessed depth, up to 60 mm
- A variety of removable pane faces
- Optical cable management tray

## Fiber Compatibility:

Maximum LC: 120 pcs  
Maximum MTP®/MPO: 384 core

## Applications:

Physical protection of fiber connection and storage of fiber slack.

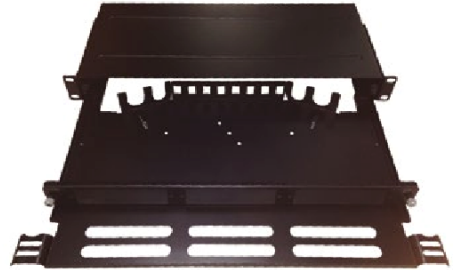

**OPTION 1:**  
3pcs x LGX cassette or adaptor panel

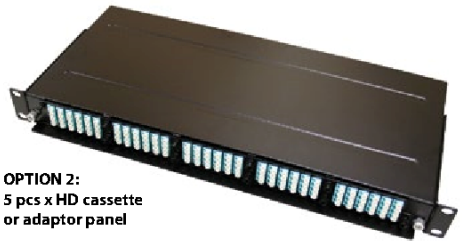

**OPTION 2:**  
5 pcs x HD cassette  
or adaptor panel

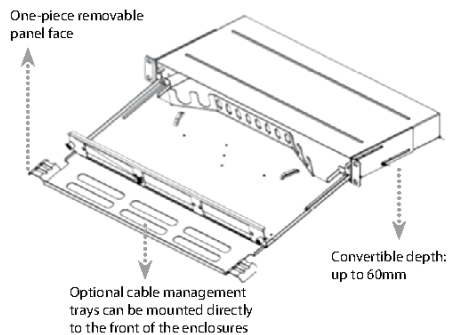

**OPTION 3:**  
Flush-mount adaptor bulkhead for ST, FC, SC and LC

## Order Information

Type of Panel	Part number	Description
3 Cassette Panel with support bar	LP-F59NC0000000001	Metal, Advanced Fiber Patch Panel, for Cassette LGX Type, 3P w/Support Bar, BK
5 Cassette Panel with support bar	LP-F59NE0000000001	Metal, Advanced Fiber Patch Panel, for Cassette HD Type, 5P w/Support Bar, BK
3 Cassette Panel w/o support bar	LP-F59OC0000000001	Metal, Advanced Fiber Patch Panel, for Cassette LGX Type, 3P w/o Support Bar, BK
5 Cassette Panel w/o support bar	LP-F59OE0000000001	Metal, Advanced Fiber Patch Panel, for Cassette HD Type, 5P w/o Support Bar, BK

# MTP®/MPO Cassette

In June 2010, the IEEE published new standards for answering Ethernet speeds of 40Gbps for server and computing applications and 100Gbps for network aggregation applications. IEEE802.3ba responds to the demand of many data centers and enterprise requiring speeds beyond 10Gbps. IEEE802.3ba specifies that communication medium is performed across copper, MMF and SMF. LanPro's 5S solution (Safety +, Space +, Speed +, Saving + and Service +) provides the efficient pre-terminated 40/100G laser optimized multimode system, as is an ideal migration path to 40/100G speeds from 10G and meets the new IEEE802.3ba standard. The system features pre-terminated trunks, harness, array cords and MTP®/MPO cassette to assist you future-proof your networks.

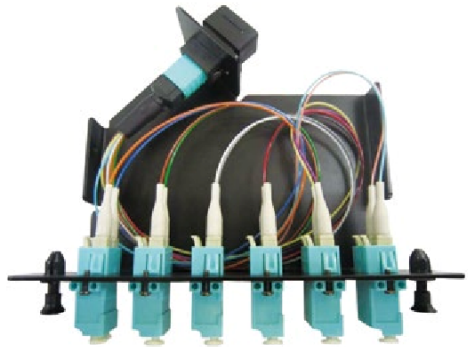

## Specifications:

SC and LC are available. PC, SPC, UPC and APC polish meet standard requirement. Each modules supports up to 12 fibers using MTP®/MPO, of 24 fibers using LC. Low loss MTP® CONNECTORS (Elite series) are deployed upon request. Bend-insensitive fibers are available too.

Method A,B, C are available  
MTP®/MPO cassette: male (female available on request)  
Weight: 0.4 Kg.

## Fiber Compatibility:

OM2, OM3, OM4, OS1/OS2

## Applications:

Provide interconnect and cross-connect of applications over installations in entrance facilities, telecommunications rooms, data centers and at desk. Allows easy migration from 10G to 40G or 4100G

OM2 (50/125um): for LED or laser-based propagation  
OM3 & OM4 (50/125um): for VCSEL -based propagation  
OS1/OS2 (9/125um): Laser -based propagation.



Left to Right: LC Duplex adaptor x 6pcs (12 ports), SC duplex adaptor x 6pcs (12 ports), LC Quad adaptor x 6pcs (24 port), LC Quad adaptor x 6pcs (24 port, vertical type is for high density cassette, up to 120 port x LC)

# MTP®/MPO Cassette

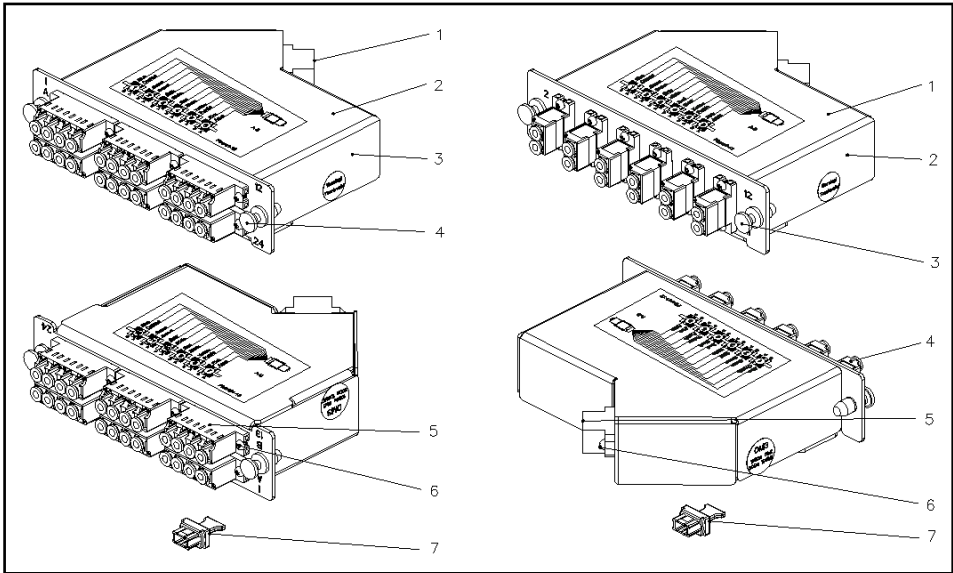

1. MTP® adaptor: A type key up to key down, 2pcs
2. Top Case: 1.5mm thickness, SPCC, BK (RAL9005)
3. Bottom case: 1.5mm thickness, SPCC, BK (RAL9005)
4. Plunger: 2pcs, Black color
5. LC adaptor: 6pcs, MM, LC quad (SC footprint), w/Zr. sleeve
6. Screw: 16pcs, M2.0 x 6.0 Zinc Plated, Black color
7. MTP® dust cover: 2pcs, Black color
8. Screw: 2pcs, M3.0 x 4.0/4.5mm Zinc plated
9. Harness patch cord (APE series): 2pcs, MTP® (male) to LC OM3 12C x 2, 30cm

1. Top Case: 1.5mm thickness, SPCC, BK (RAL9005)
2. Bottom case: 1.5mm thickness, SPCC, BK (RAL9005)
3. Plunger: 2pcs, Black color
4. LC adaptor: 6pcs, MM, LC duplex (SC footprint), w/Zr. sleeve
5. MTP® adaptor: A type key up to key down, 1pc
6. Screw: 14pcs, M2.0 x 6.0 Zinc Plated, Black color
7. MTP® dust cover: 1pc, Black color
8. Screw: 2pcs, M3.0 x 4.0/4.5mm Zinc plated
9. Harness patch cord (APE series): 1pc, MTP® (male) to LC OM3 12C x 1, 30cm



# Order Information

**LP-F58 BB 01 01 1 026 29**

LP-F58	CASSETTE TYPE		COLOR		METHOD	MTP®/MPO		
LANPRO MTP®/MPO CASSETTE HD TYPE	AA	12P LGX Type	01	BK	01	Method A,C	1	MPO Flange Type, MM, (Key Up-Down), BK
	AB	24P LGX Type			02	Method B	2	MPO Flange Type, MM, (Key Up-Up), BK
	BB	24P HD Type			03	Method B Distaled	3	MTP® Flange Type, MM, (Key Up-Down), BK
							4	MTP® Flange Type, MM, (Key Up-Up), Light Gray

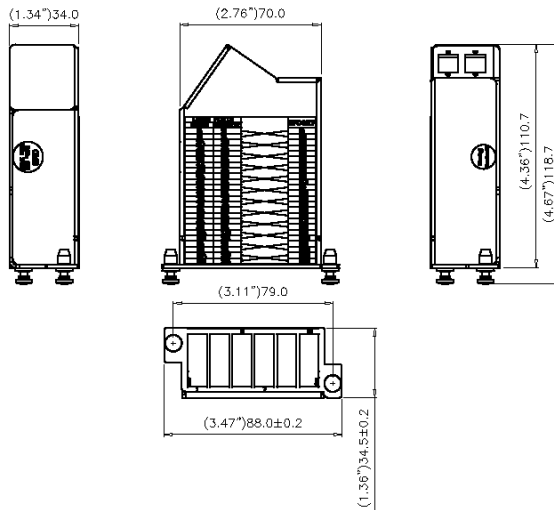

## Example:

**LP-F58BB0101102629** Fiber Optic MPO Cassette, 24P HD Type method A, MPO flange type, MM, (Key Up-Down), Direct Harness, OM3,50/125um, Corning, 12C, 0.9mm Jacket, Mix, PVC, 12 F MPO+Guide Pin (MM Low Loss), LC (MM Low Loss), LC-LC, Flange Type, MM, Duplex, w/Zr Sleeve, One Piece Type, AQ, Black color cassette.

# Order Information

**LP-F58 BB 01 01 1 026 29**

DIRECT HARNESS		LC/SC ADAPTOR	
026	Direct Harness, OM3,50/125um, Corning, 12C, 0.9mm Jacket, Mix, PVC, 12 F MPO+Guide Pin (MM Low Loss)-LC (MM Low Loss), even-alignment, 30cm.	05	LC-LC, Flange Type, MM, Quad, w/PB Sleeve, One Piece Type, IV
027	Direct Harness, OM4,50/125um, Corning, 12C, 0.9mm Jacket, Mix, PVC, 12 F MPO+Guide Pin (MM Low Loss)-LC (MM Low Loss), even-alignment, 30cm.	31	LC-LC, Flange Type, MM, Quad, w/Zr Sleeve, One Piece Type, AQ
034	Direct Harness, MM, 50/125um, 12C, 0.9mm Jacket, Mix, PVC, 12 F MPO+Guide Pin(MM)-LC(MM), even-alignment, 30cm.	07	LC-LC, Flange Type, 5M, Quad, w/Zr Sleeve, One Piece Type, BL
035	Direct Harness, OM3,50/125um, Corning, 12C, 0.9mm Jacket Mix, PVC, 12 F MPO+Guide Pin (MM), -LC (MM), even-alignment, 30cm.	08	LC-LC, Flange Type, 5M, Quad, w/Zr Sleeve, One Piece Type, GN
036	Direct Harness, OM4,50/125um, Corning, 12C, 0.9mm Jacket Mix, PVC, 12 F MPO+Guide Pin (MM), -LC (MM), even-alignment, 30cm.	09	LC-LC, Flange Type, MM, Duplex, w/PB Sleeve, One Piece Type, AQ
039	Direct Harness, 5M (G652D), 9/125um, Corning, 12C, 0.9mm Jacket Mix, PVC, 12 F MPO+Guide Pin (5M APC), -LC (5M UPC), even-alignment, 30cm.	29	LC-LC, Flange Type, MM, Duplex, w/Zr Sleeve, One Piece Type, AQ
040	Direct Harness, 5M (G657A2), 9/125um, Corning, 12C, 0.9mm Jacket Mix, PVC, 12 F MPO+Guide Pin (5M APC), -LC (5M UPC), even-alignment, 30cm.	11	LC-LC, Flange Type, 5M, Duplex, w/Zr Sleeve, One Piece Type, BL
041	Direct Harness, 5M (G652D), 9/125um, Corning, 12C, 0.9mm Jacket Mix, PVC, 12 F MPO+Guide Pin (5M APC), -LC (5M APC), even-alignment, 30cm.	12	LC-LC, Flange Type, 5M, Duplex, w/Zr Sleeve, One Piece Type, GN
042	Direct Harness, 5M (G657A2), 9/125um, Corning, 12C, 0.9mm Jacket Mix, PVC, 12 F MPO+Guide Pin (5M APC), -LC (5M APC), even-alignment, 30cm.	17	LC-LC, Flangeless Type, MM, Quad, w/PB Sleeve, One Piece Type, IV
047	Direct Harness, 5M (G652D), 9/125um, Corning, 12C, 0.9mm Jacket Mix, PVC, 12 F MPO+Guide Pin (5M APC Low Loss), -LC (5M APC), even-alignment, 30cm.	32	LC-LC, Flangeless Type, MM, Quad, w/Zr Sleeve, One Piece Type, AQ
048	Direct Harness, 5M (G657A2), 9/125um, Corning, 12C, 0.9mm Jacket Mix, PVC, 12 F MPO+Guide Pin (5M APC Low Loss), -LC (5M APC), even-alignment, 30cm.	19	LC-LC, Flangeless Type, 5M, Quad, w/Zr Sleeve, One Piece Type, BL
226	Direct Harness, OM3, 50/125um, Corning, 12C, 0.9mm Jacket Mix, PVC, 12 F MTP*+Guide Pin (MM Low Loss), -LC (MM Low Loss), even-alignment, 30cm.	20	LC-LC, Flangeless Type, 5M, Quad, w/Zr Sleeve, One Piece Type, GN
227	Direct Harness, OM4, 50/125um, Corning, 12C, 0.9mm Jacket Mix, PVC, 12 F MTP*+Guide Pin (MM Low Loss), -LC (MM Low Loss), even-alignment, 30cm.		
234	Direct Harness, MM, 50/125um, 12C, 0.9mm Jacket Mix, PVC, 12 F MTP*+Guide Pin (MM), -LC (MM), even-alignment, 30cm.		
235	Direct Harness, OM3,50/125um, Corning, 12C, 0.9mm Jacket Mix, PVC, 12 F MTP*+Guide Pin (MM), -LC (MM), even-alignment, 30cm.		
236	Direct Harness, OM4,50/125um, Corning, 12C, 0.9mm Jacket Mix, PVC, 12 F MTP*+Guide Pin (MM), -LC (MM), even-alignment, 30cm.		
239	Direct Harness, 5M (G652D), 9/125um, Corning, 12C, 0.9mm Jacket, Mix, PVC, 12 F MTP*+Guide Pin (5M APC), -LC (5M UPC), even-alignment, 30cm.		
240	Direct Harness, 5M (G657A2), 9/125um, Corning, 12C, 0.9mm Jacket, Mix, PVC, 12 F MTP*+Guide Pin (5M APC), -LC (5M UPC), even-alignment, 30cm.		
241	Direct Harness, 5M (G652D), 9/125um, Corning, 12C, 0.9mm Jacket, Mix, PVC, 12 F MTP*+Guide Pin (5M APC), -LC (5M APC), even-alignment, 30cm.		
242	Direct Harness, 5M (G657A2), 9/125um, Corning, 12C, 0.9mm Jacket, Mix, PVC, 12 F MTP*+Guide Pin (5M APC), -LC (5M APC), even-alignment, 30cm.		
247	Direct Harness, 5M (G652D), 9/125um, Corning, 12C, 0.9mm Jacket, Mix, PVC, 12 F MTP*+Guide Pin (5M APC Low Loss), -LC (5M APC), even-alignment, 30cm.		
248	Direct Harness, 5M (G657A2), 9/125um, Corning, 12C, 0.9mm Jacket, Mix, PVC, 12 F MTP*+Guide Pin (5M APC Low Loss), -LC (5M APC), even-alignment, 30cm.		

**Example:**

**LP-F58BB0101102629** Fiber Optic MPO Cassette, 24P HD Type method A, MPO flange type, MM, (Key Up-Down), Direct Harness, OM3,50/125um, Corning, 12C, 0.9mm Jacket, Mix, PVC, 12 F MPO+Guide Pin (MM Low Loss)-LC (MM Low Loss), LC-LC, Flange Type, MM, Duplex, w/Zr Sleeve, One Piece Type, AQ, Black color cassette.

# Order Information

**LP-F58 AA 01 01 1 002 27**

LP-F58	CASSETTE TYPE		COLOR		METHOD		MPO/MTP*	
LANPRO LANPRO MTP*/MPO CASSETTE LGX TYPE	AA	12P LGX Type	01	BK	01	Method A,C	1	MPO Flange Type, MM, (Key Up-Down), BK
					02	Method B	2	MPO Flange Type, MM, (Key Up-Up), BK
					03	Method B Distaled	3	MTP* Flange Type, MM, (Key Up-Down), BK
							4	MTP* Flange Type, MM, (Key Up-Up), Light Gray

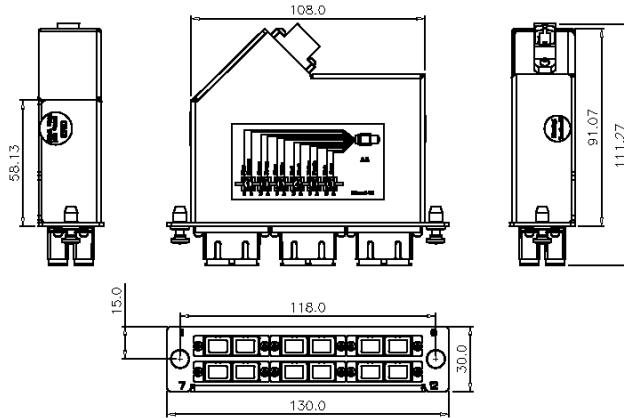

**Example:**

**LP-F58AA0101100227** Fiber Optic MPO Cassette, 12P LGX Type method A, MPO flange type, MM, (Key Up-Down), Direct Harness, OM3,50/125um, Corning, 12C, 0.9mm Jacket, Mix, PVC, 12 F MPO+Guide Pin (MM Low Loss),-SC II (MM Low Loss), SC-SC, Flange Type, MM, Duplex, w/Zr Sleeve, One Piece Type, AQ, Black color cassette

# Order Information

**LP-F58 AA 01 01 1 002 27**

DIRECT HARNESS		LC/SC ADAPTOR	
002	Direct Harness, OM3, 50/125um, Corning, 12C, 0.9mm Jacket, Mix, PVC, 12 F MPO+Guide Pin (MM Low Loss)-SC II (MM Low Loss), even-alignment, 30cm	01	SC-SC, Flange Type, MM, Duplex,w/PB Sleeve, One Piece Type, IV
003	Direct Harness, OM4, 50/125um, Corning, 12C, 0.9mm Jacket, Mix, PVC, 12 F MPO+Guide Pin (MM Low Loss)-SC II (MM Low Loss), even-alignment, 30cm	27	SC-SC, Flange Type, MM, Duplex,w/Zr Sleeve, One Piece Type, AQ
010	Direct Harness, MM, 50/125um, 12C, 0.9mm Jacket, Mix, PVC, 12 F MPO+Guide Pin(MM)-LC(MM), even-alignment, 30cm.	03	SC-SC, Flange Type, 5M, Duplex,w/Zr Sleeve, One Piece Type, BL
011	Direct Harness, OM3, 50/125um, Corning, 12C, 0.9mm Jacket Mix, PVC, 12 F MPO+Guide Pin (MM), -SC II (MM), even-alignment, 30cm	04	SC-SC, Flange Type, 5M, Duplex,w/Zr Sleeve, One Piece Type, GN
012	Direct Harness, OM4, 50/125um, Corning, 12C, 0.9mm Jacket Mix, PVC, 12 F MPO+Guide Pin (MM), -SC II (MM), even-alignment, 30cm		
015	Direct Harness, 5M, (G652D), 9/125um Corning, 12C, 0.9mm Jacket Mix, PVC, 12 F MPO+Guide Pin (5M APC), -SC II (5M UPC), even-alignment, 30cm		
016	Direct Harness, 5M, (G657A2), 9/125um Corning, 12C, 0.9mm Jacket Mix, PVC, 12 F MPO+Guide Pin (5M APC), -SC II (5M UPC), even-alignment, 30cm		
017	Direct Harness, 5M, (G652D), 9/125um Corning, 12C, 0.9mm Jacket Mix, PVC, 12 F MPO+Guide Pin (5M APC), -SC II (5M APC), even-alignment, 30cm		
018	Direct Harness, 5M, (G657A2), 9/125um Corning, 12C, 0.9mm Jacket Mix, PVC, 12 F MPO+Guide Pin (5M APC), -SC II (5M APC), even-alignment, 30cm		
023	Direct Harness, 5M, (G652D), 9/125um Corning, 12C, 0.9mm Jacket Mix, PVC, 12 F MPO+Guide Pin (5M APC Low Loss), -SC II (5M APC), even-alignment, 30cm		
024	Direct Harness, 5M, (G657A2), 9/125um Corning, 12C, 0.9mm Jacket Mix, PVC, 12 F MPO+Guide Pin (5M APC Low Loss), -SC II (5M APC), even-alignment, 30cm		
202	Direct Harness, OM3,50/125um Corning, 12C, 0.9mm Jacket Mix, PVC, 12 F MTP*+Guide Pin (MM Low Loss), -SC II (MM Low Loss), even-alignment, 30cm		
203	Direct Harness, OM4,50/125um Corning, 12C, 0.9mm Jacket Mix, PVC, 12 F MTP*+Guide Pin (MM Low Loss), -SC II (MM Low Loss), even-alignment, 30cm		
210	Direct Harness, MM,50/125um, 12C, 0.9mm Jacket Mix, PVC, 12 F MTP*+ Guide Pin (MM), -SC II (MM), even-alignment, 30cm		
211	Direct Harness, OM3,50/125um, Corning, 12C, 0.9mm Jacket Mix, PVC, 12 F MTP*+Guide Pin (MM), -SC II (MM), even-alignment, 30cm		
212	Direct Harness, OM4,50/125um, Corning, 12C, 0.9mm Jacket Mix, PVC, 12 F MTP*+Guide Pin (MM), -SC II (MM), even-alignment, 30cm		
215	Direct Harness, 5M (G652D), 9/125 um, Corning, 12C, 0.9mm Jacket Mix, PVC, 12 F MTP*+Guide Pin (5M APC), -SC II (5M UPC), even-alignment, 30cm		
216	Direct Harness, 5M (G657A2), 9/125 um, Corning, 12C, 0.9mm Jacket Mix, PVC, 12 F MTP*+Guide Pin (5M APC), -SC II (5M UPC), even-alignment, 30cm		
217	Direct Harness, 5M (G652D), 9/125 um, Corning, 12C, 0.9mm Jacket Mix, PVC, 12 F MTP*+Guide Pin (5M APC), -SC II (5M APC), even-alignment, 30cm		
218	Direct Harness, 5M (G657D), 9/125 um, Corning, 12C, 0.9mm Jacket Mix, PVC, 12 F MTP*+Guide Pin (5M APC), -SC II (5M APC), even-alignment, 30cm		
223	Direct Harness, 5M (G652D), 9/125 um, Corning, 12C, 0.9mm Jacket Mix, PVC, 12 F MTP*+Guide Pin (5M APC Low Loss), -SC II (5M APC), even-alignment, 30cm		
224	Direct Harness, 5M (G657A2), 9/125 um, Corning, 12C, 0.9mm Jacket Mix, PVC, 12 F MTP*+Guide Pin (5M APC Low Loss), -SC II (5M APC), even-alignment, 30cm		

**Example:**

**LP-F58AA0101100227** Fiber Optic MPO Cassette, 12P LGX Type method A, MPO flange type, MM, (Key Up-Down), Direct Harness, OM3,50/125um, Corning, 12C, 0.9mm Jacket, Mix, PVC, 12 F MPO+Guide Pin (MM Low Loss), -SC II (MM Low Loss), SC-SC, Flange Type, MM, Duplex, w/Zr Sleeve, One Piece Type, AQ, Black color cassette

# Ultra Slim Fiber Enclosure Series 96 & 144 port

## Specifications:

1U panel can scale up to 96 and 144 discrete LC connectors and up to 8 and 12 x MTP®/MPO

## Fiber Compatibility:

OM1, OM2, OM3, OM4, OS1/OS2

## Applications:

Data communication and data center infrastructure and fiber channel for storage area network

OM1 (62.5/125um): for LED-based propagation

OM2 (50/125um): for LED or laser-based propagation

OM3 & OM4 (50/125um): for VCSEL-based propagation

OS1/OS2 (9/125um): Laser-based propagation

This series supports extraordinary advantage:

- 1U size up to 144 port: 13cm depth saves space and makes the Panel compatible with copper racking system
- Rapid Deployment: Factory terminated modular system saves Installation and reconfiguration time during moves, adds and Changes
- Reliability-100% tested: Combination of high quality components and LanPro manufacturing quality control guarantees product to the highest standards.

Flexible option: Protrude or Inner version

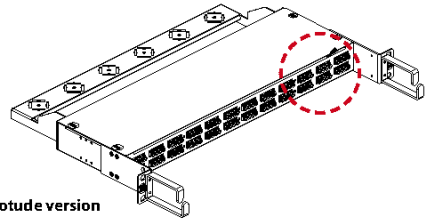

Protrude version

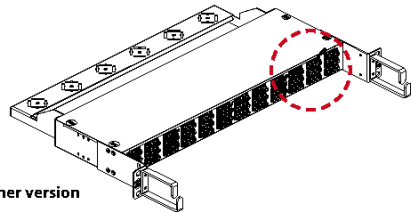

Inner version

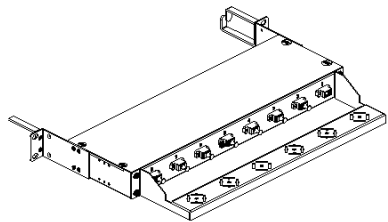

Rear side: LC x 96 port with MTP®/MPO x 8 pcs

## Order Information

Code	Panel Type	Description
LP-F58CA0100103532	96 Port Inner	MPO Flange Type, Key Up-Down, BK; Direct Harness, OM3 12C 0.9mm Jacket, Mix.. color, PVC, 12 F MPO+Guide Pin (MM), LC (MM), 30cm; LC Flangeless Adaptor, MM, Quad, w/Zr. Sleeve, AQ.
LP-F58CA0100103919	96 Port Inner	MPO Flange Type, Key Up-Down, BK; Direct Harness, SM (G6252D) 12C 0.9mm Jacket, Mix.. color, PVC, 12 F MPO+Guide Pin (SM APC), LC (SM UPC), 30cm; LC Flangeless Adaptor, SM, Quad, w/Zr. Sleeve, BL
LP-F58CA0100104120	96 Port Inner	MPO Flange Type, Key Up-Down, BK; Direct Harness, SM (G625D) 12C 0.9mm Jacket, Mix.. color, PVC, 12 F MPO+Guide Pin (SM APC), LC (SM APC), 30cm; LC Flangeless Adaptor, SM, Quad, w/Zr. Sleeve, GN
LP-F58CA100323532	96 Port Inner	MTP® Flange Type, Key Up-Down, BK; Direct Harness, OM3 12C 0.9mm Jacket, Mix.. color, PVC, 12 F MTP®+Guide Pin (MM), LC (MM), 30cm; LC Flangeless Adaptor, MM, Quad, w/Zr. Sleeve, AQ
LP-F58CA100323919	96 Port Inner	MTP® Flange Type, Key Up-Down, BK; Direct Harness, SM (G625D) 12C 0.9mm Jacket, Mix.. color, PVC, 12 F MTP®+Guide Pin (SM APC), LC (SM UPC), 30cm; LC Flangeless Adaptor, SM, Quad, w/Zr. Sleeve, BL
LP-F58CA0100324120	96 Port Inner	MTP® Flange Type, Key Up-Down, BK; Direct Harness, SM (G625D) 12C 0.9mm Jacket, Mix.. color, PVC, 12 F MTP®+Guide Pin (SM APC), LC (SM APC), 30cm; LC Flangeless Adaptor, SM, Quad, w/Zr. Sleeve, GN
LP-F58CB0100103532	144 Port Inner	MPO Flange Type, Key Up-Down, BK; Direct Harness, OM3 12C 0.9mm Jacket, Mix.. color, PVC, 12 F MPO+Guide Pin (MM), LC (MM), 30cm; LC Flangeless Adaptor, MM, Quad, w/Zr. Sleeve, AQ
LP-F58CB100103919	144 Port Inner	MPO Flange Type, Key Up-Down, BK; Direct Harness, SM (G625D) 12C 0.9mm Jacket, Mix.. color, PVC, 12 F MPO+Guide Pin (SM APC), LC (SM UPC), 30cm; LC Flangeless Adaptor, SM, Quad, w/Zr. Sleeve, BL
LP-F58CB0100104120	144 Port Inner	MPO Flange Type, Key Up-Down, BK; Direct Harness, SM (G625D) 12C 0.9mm Jacket, Mix.. color, PVC, 12 F MPO+Guide Pin (SM APC), LC (SM APC), 30cm; LC Flangeless Adaptor, SM, Quad, w/Zr. Sleeve, GN
LP-F58CB0100323532	144 Port Inner	MTP® Flange Type, Key Up-Down, BK; Direct Harness, OM3 12C 0.9mm Jacket, Mix.. color, PVC, 12 F MTP®+Guide Pin (MM), LC (MM) 30cm; LC Flangeless Adaptor, MM, Quad, w/Zr. Sleeve, AQ
LP-F58CB0100323919	144 Port Inner	MTP® Flange Type, Key Up-Down, BK; Direct Harness, SM (G625D) 12C 0.9mm Jacket, Mix.. color, PVC, 12 F MTP®+Guide Pin (SM APC), LC (SM UPC) 30cm; LC Flangeless Adaptor, SM, Quad, w/Zr. Sleeve, BL
LP-F58CB0100324120	144 Port Inner	MTP® Flange Type, Key Up-Down, BK; Direct Harness, SM (G625D) 12C 0.9mm Jacket, Mix.. color, PVC, 12 F MTP®+Guide Pin (SM APC), LC (SM APC) 30cm; LC Flangeless Adaptor, SM, Quad, w/Zr. Sleeve, GN
LP-F58DA0100103532	96 Port Protrude	MPO Flange Type, Key Up-Down, BK; Direct Harness, OM3 12C 0.9mm Jacket, Mix.. color, PVC, 12 F MPO+Guide Pin (MM), LC (MM), 30cm; LC Flangeless Adaptor, MM, Quad, w/Zr. Sleeve, AQ
LP-F58DA0100103919	96 Port Protrude	MPO Flange Type, Key Up-Down, BK; Direct Harness, SM (G625D) 12C 0.9mm Jacket, Mix.. color, PVC, 12 F MPO+Guide Pin (SM APC), LC (SM UPC), 30cm; LC Flangeless Adaptor, SM, Quad, w/Zr. Sleeve, BL
LP-F58DA0100104120	96 Port Protrude	MPO Flange Type, Key Up-Down, BK; Direct Harness, SM (G625D) 12C 0.9mm Jacket, Mix.. color, PVC, 12 F MPO+Guide Pin (SM APC), LC (SM APC), 30cm; LC Flangeless Adaptor, SM, Quad, w/Zr. Sleeve, GN

# Order Information

Code	Panel Type	Description
LP-F58CA0100103532	96 Port Inner	MPO Flange Type, Key Up-Down, BK; Direct Harness, OM3 12C 0.9mm Jacket, Mix.. color, PVC, 12 F MPO+Guide Pin (MM), LC (MM), 30cm; LC Flangeless Adaptor, MM, Quad, w/Zr. Sleeve, AQ.
LP-F58CA0100103919	96 Port Inner	MPO Flange Type, Key Up-Down, BK; Direct Harness, SM (G625D) 12C 0.9mm Jacket, Mix.. color, PVC, 12 F MPO+Guide Pin (SM APC), LC (SM APC), 30cm; LC Flangeless Adaptor, SM, Quad, w/Zr. Sleeve, BL
LP-F58CA0100104120	96 Port Inner	MTP® Flange Type, Key Up-Down, BK; Direct Harness, SM (G625D) 12C 0.9mm Jacket, Mix.. color, PVC, 12 F MTP®+Guide Pin (SM APC), LC (SM APC) 30cm; LC Flangeless Adaptor, SM, Quad, w/Zr. Sleeve, GN
LP-F58CA100323532	96 Port Inner	MTP® Flange Type, Key Up-Down, BK; Direct Harness, OM3 12C 0.9mm Jacket, Mix.. color, PVC, 12 F MTP®+Guide Pin (MM), LC (MM), 30cm; LC Flangeless Adaptor, MM, Quad, w/Zr. Sleeve, AQ
LP-F58CA100323919	96 Port Inner	MTP® Flange Type, Key Up-Down, BK; Direct Harness, SM (G625D) 12C 0.9mm Jacket, Mix.. color, PVC, 12 F MTP®+Guide Pin (SM APC), LC (SM UPC), 30cm; LC Flangeless Adaptor, SM, Quad, w/Zr. Sleeve, BL
LP-F58CA0100324120	96 Port Inner	MPO Flange Type, Key Up-Down, BK; Direct Harness, SM (G625D) 12C 0.9mm Jacket, Mix.. color, PVC, 12 F MPO+Guide Pin (SM APC), LC (SM APC) 30cm; LC Flangeless Adaptor, SM, Quad, w/Zr. Sleeve, GN
LP-F58CB0100103532	144 Port Inner	MPO Flange Type, Key Up-Down, BK; Direct Harness, OM3 12C 0.9mm Jacket, Mix.. color, PVC, 12 F MPO+Guide Pin (MM), LC (MM), 30cm; LC Flangeless Adaptor, MM, Quad, w/Zr. Sleeve, AQ
LP-F58CB100103919	144 Port Inner	MPO Flange Type, Key Up-Down, BK; Direct Harness, SM (G625D) 12C 0.9mm Jacket, Mix.. color, PVC, 12 F MPO+Guide Pin (SM APC), LC (SM UPC), 30cm; LC Flangeless Adaptor, SM, Quad, w/Zr. Sleeve, BL

• All Panel w/Support Bar, color = RAL9005 Black

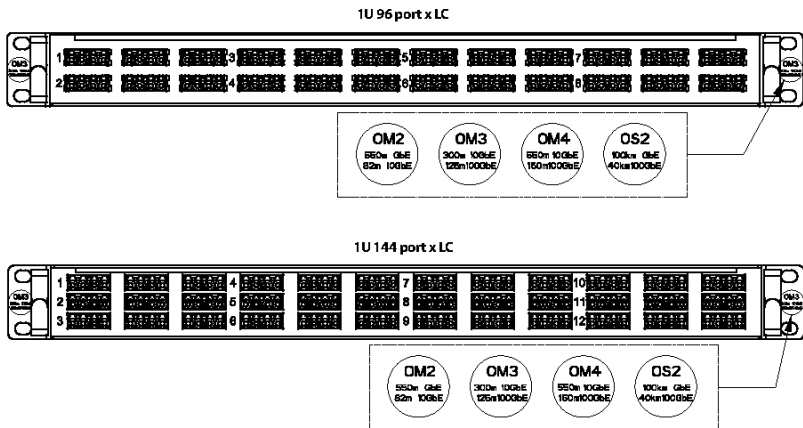

# Plastic Fiber Enclosures (FTTH)

2, 4 or 8, 12 and 24 ports, Plastic Fiber Enclosures.

These boxes have been designed for termination of FTTH cables arriving to customer premises and the orderly arrangement and identification of splices, pigtails and adaptors. They can be installed on walls or masts with a variety of options and styles of optical connection. They are made with high quality ABS material, and the arrangement of the design permits a comfortable accommodation of up to 12 fibers and the corresponding LC or SC adaptors with the structural details that give the fiber a flex radius of 30 mm minimum.



## Specifications:

- They are Wall or Mast Mountable.
- Made of High quality ABS material, (White or Oyster color).
- Adaptors are not included. (Can be loaded with 12 LC or SC adaptors under special order).

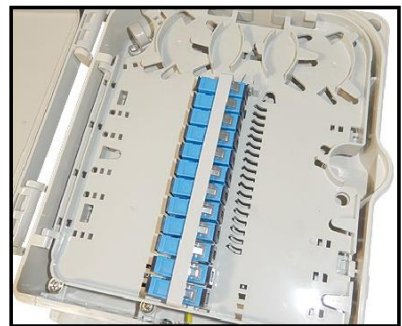
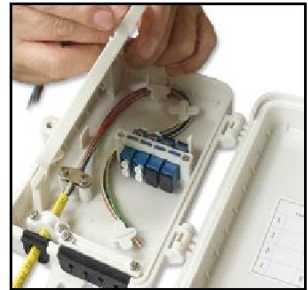



# Order Information

**LP-F 20 5 G OY 20 S1**

LP-F	PLASTIC FIBER OPTIC WALL ENCLOSURES		BOX/PANEL TYPE		PORTS		BOX/PANEL COLOR		ADAPTOR PLATE		SLEEVE TYPE	
LANPRO PLASTIC FIBER ENCLOSURES	20	FTTH Fiber Optic Terminal Box	5	Plastic Box, Pole or Wall Mountable	2	2 Ports	IV	Ivory	00	Without adaptor plate	M1	Multimode Phosphor Bronze Sleeve
	21	FTTH Fiber Optic Terminal Box Small Enclosure			4	4 Ports	BK	Black	01	ST Thread Type	S1	Singlemode Zirconia Sleeve
	8	8 Ports			GR	Gray	02	ST Flange Type	Blank Don't care			
	A	12 Ports			OY	Oyster White	03	ST Duplex Type				
	B	24 Ports			WH	White	04	FC/PC Metal Square Type				
	C	36 Ports			05	FC/PC Metal D Type						
	D	48 Ports			06	FC/PC Flange Type						
	E	12 and 24			07	FC/PC Flange Type						
	F	36 and 48			08	SC Duplex Type						
	G	4 or 8			09	ST to FC Hybrid Type						
	10	ST to SC Hybrid Type										
	11	FC to SC Hybrid Type										
	12	ST to SC Duplex Type										
13	MTRJ Type											
14	LC Duplex Square Type											
15	LC Duplex Square Type											
16	LC Duplex Footprint Type											
18	SC Flangeless Type											
19	SC Duplex Flangeless Type											
20	SC Quad Flangeless Type											
XX	Mixed Adaptor Type											

**Example:**

LP-F205GOY20S1 Fiber Optic terminal plastic box FTTH, Pole or Wall mountable with 4 SC Singlemode Adaptors, Oyster White color.

# Universal Fiber Enclosure

LanPro Horizontal Fiber Optical Splice Closure 4 port for 48 single cores or up to 96 tape shaped cores this product can be applied in the straight line and branch line (one into two, one into three) connections of optical cables within a diameter of 22 mm( $\phi$ ), all types and structures, when laid overhead, in the pipeline, underground or in the well.

It is also applied to the connection of all-plastic city phone cables.

## Specifications:

- External Size (length×width×height) [mm]: 435 × 190 × 120
- Weight [Kg]: 2.5
- Optical fiber winding radius [mm]:  $\geq 40$
- Extra loss of fiber tray [dB]:  $\leq 0.01$
- Fiber length left in tray [m]:  $\geq 1.6$
- Fiber capacity Single: 48 cores, Tape-shaped: 96 cores
- Working temperature [°C]: - 40~ + 70
- Lateral pressure-resistance [N/10cm]:  $\geq 2000$
- Shock-resistance [N.m]:  $\geq 20$
- 4 Port for 48 single cores or up to 96 tape shaped cores.

## Applications:

- The case body is made from high-intensity engineering plastics (ABS) and the shape formed with mould plastics under high pressure. It is in the shape of HALF rectangle, with the advantages of less weight, high mechanical resistance, corrosive - resistance, anti-thunderstruck and long service life.
- The case body and cable entrance are sealed with adhesive rubber strip (non-vulcanized) and sealed tape. Reliable sealing capability. It can be re-opened and easy to maintain.
- Unique disposition of 4 different cable loops ( $\phi 12.5$ ,  $\phi 17$ ,  $\phi 20$ ,  $\phi 22$ ) enables the user to choose different the outer diameter according to actual conditions, it enhances the reliability of the cable entrance sealing.



- Overlapping fiber-melting tray and separate insulation earth unit make the disposition of the cores, expanding the capacity and cable-earthing flexible, convenient and safe.
- Outer metal component and fixing unit are made of stainless steel, so it can be repeatedly used in different environments.
- Versatile Installation: Can be used aerial, buried or screwed to walls or poles.

# Order Information

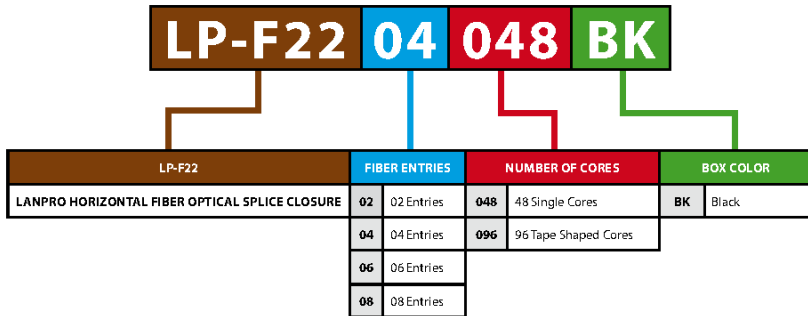

**Example:**

LP-F2204048BK Fiber Optic Horizontal splice closure, 4 ports for up to 48 cores, black color box.

# Fiber Distribution Cabinets

## Specifications:

- 19" standard installation.
- Fully closed structure to ensure the fiber protection, dust proof.
- Cold rolled steel body with integrated structure, electrostatic spraying surface.
- High intensity, good rigidity and sharp appearance, several types of distribution boxes are selectable according customer's requirements.
- Optical cable can be led in/out from the top or the bottom of frame.
- Including splicing, distribution, maintenance, cable/fiber fixing and grounding, operation can be done on both front and rear sides.
- Side panels can be dismantled in order to lead in/out fibers inter optical distribution frame.
- Horizontal fiber tray, vertical fiber tray, and fiber hanging ring make it easy to guide fibers, optimizing the whole distribution system.
- Kinds of arc kits and protection accessories along the fiber path ensure the minimum ratio of fibers more than 40mm.
- Cable fixed plate protect optical cable from torsion and pull.
- Suitable for ordinary optical fiber or ribbon optical fiber. LP-D72 allow 72 connectors per tray. Up to 10 per rack.

## Applications:

These ODF are a fit for splicing, connection and distribution of fibers with large capacity. Normally it is used for backbone cable distribution at exchange side in an optical access network.



# Fiber Optic Cable Colors. Realities and Myths.

There has been a need to differentiate optical cables in the field, and color has been an easy way to do it. We briefly review the common practice related to the use of coloring for the identification of optical cables in the Telecom Industry.

The following table shows the sheath or jacket colors used for identifying the type of fiber core used in optical fiber cables utilized in **patchcords or zipcords**.

<b>TYPE OF FIBER CORE BY CABLE SHEATH COLOR (as per the TIA-598-C Standard)</b>
<b>Singlemode Optical Fiber Core (OS1, OS2)</b>
<b>Multimode Optical Fiber Core (OM1, OM2)</b>
<b>Multimode Optical Fiber Core 50/125 <math>\mu</math>m Optimized for 10 Gbps Laser (OM3, OM4)</b>
<b>Not used in new systems for Multimode fiber cores</b>
<b>Maintained Polarization Singlemode Fiber Optic Core</b>

**THE INTERNAL OR EXTERNAL DISTRIBUTION FIBER CABLES DOESN'T NEED TO COMPLY WITH A PARTICULAR SHEATH COLOR. A DISTRIBUTION CABLE COULD BE BLACK COLORED LIKE THE POLYETHYLENE JACKET CABLES USED IN OUTDOOR OR THE COLOR USED BY THE MANUFACTURER OR FROM THE CUSTOMER'S CHOICE.**

This scheme **DOES NOT APPLY** when the cables are for interior or exterior environment distribution. Some manufacturers use bright colors that differentiate them from copper cabling, and could also be black or black with colored stripes. The legend printed on the sheath or jacket should be read in order to know the exact type of cable dealt with. In a distribution cable, the color has no practical meaning.

Depending on the fiber core contained in the cable, some manufacturers use non common colors like violet or color combinations with color stripes. In the same token, connectors also help in the identification of fiber cores as shown in the following table:

## COLOR CODE FOR CONNECTORS

PC, 0°

Mainly used for singlemode Fiber, but some manufacturers use it also for multimode.

APC, 8°

Singlemode only

PC, 0°

Multimode 50/125µm Fiber

PC, 0°

Multimode 62.5/125µm Fiber

PC, 0°

Singlemode Fiber

High Optic Power Laser connection

The connector's color coding refers mostly to the color of the boot which is shown in the next photo. Some manufacturers don't follow this scheme and use their own colors.

The red color is used by Telecom Companies to warn on high optical power signals that serve many customers in a distribution scheme.

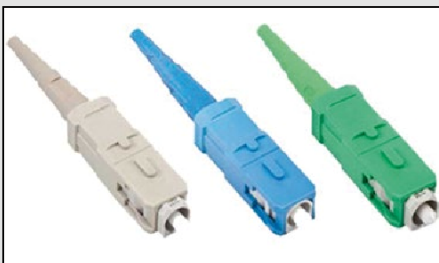

## WARNING

Never observe a fiber optic connector if you ignore if there is a signal output through it. Invisible light doesn't mean it is not dangerous to the human eyes. Red colored connectors output optical power is high enough to burn and damage a large zone of the retina, causing permanent burn and irreversible blindness.

In the next photo, a severe retina burn is shown caused by a high power laser. Though the light cannot be seen, it is capable of this type of damage.

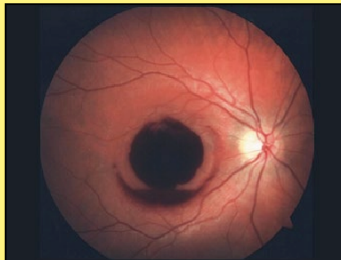

Finally, a color coding also exist in The individual cores inside the cable, being them inside of loose tubes or embedded in the cable jacket, the TIA-598 is the most accepted color coding as is shown in the following table:

**INDIVIDUAL FIBERS COLOR (AS PER THE TIA-598-C)**

POSITION	COLOR	POSITION	COLOR
1	Blue	13	Blue with black stripe
2	Orange	14	Orange with black stripe
3	Green	15	Green with black stripe
4	Brown	16	Brown with black stripe
5	Grey	17	Grey with black stripe
6	White	18	White with black stripe
7	Red	19	Red with black stripe
8	Black	20	Black with yellow stripe
9	Yellow	21	Yellow with black stripe
10	Violet	22	Violet with black stripe
11	Rose	23	Rose with black stripe
12	Aqua	24	Aqua with black stripe

After the 12th core, the 13th repeats the sequence again (blue), like the number 1.

## Heat-shrinkable Single Fiber Fusion Splice Protection Sleeve

### Specifications:

- For one fiber.
- Heat-shrinkable.
- Diameters from 1.0 to 3.7 mm.
- Lengths from 25 to 60 mm.
- Clear color standard, colored for production batch.
- For fiber diameters of 250  $\mu\text{m}$  / 900  $\mu\text{m}$ .
- With strength members of stainless steel, fibre-reinforced plastic (FRP) or flexible types.
- Tapered or not tapered ends.
- Bags with 25/50 or 100 pieces.



### Applications:

Heat-shrinkable Single Fiber Fusion Splice Protection Sleeves is part of the fiber optic system solutions by LanPro for today's structured fiber optic cabling systems.

Heat-shrinkable splice protection is the most popular way to protect fusion splices. Coated fibers of 250 or 900  $\mu\text{m}$  diameter are securely protected once they are stripped from the protection of their buffer and fused to make the splice.

In order to use the LP-F35XX, the technician must slide it on the fiber before making the splice. Once the fusion takes place, the sleeve should be slid so the splice is located in the middle of the LP-F35XX and then it must be placed on the heat-shrink oven. The oven heating time should be selected, depending on the type of sleeve. Once done, the LP-F35XX should be placed in its location on the tray in the order selected.

LanPro is able to provide several sizes of Heat-shrinkable Single Fiber Fusion Splice Protection Sleeves, from micro sized diameter of 1.0 mm to 3.7 mm and lengths from 25 mm to 60 mm. With strength members of stainless steel, fibre-reinforced plastic (FRP) or flexible types.

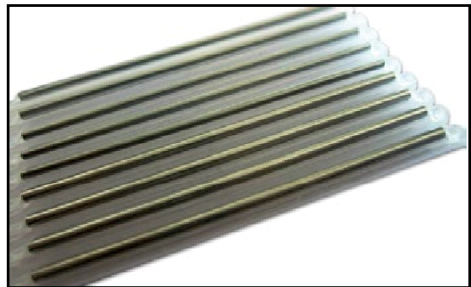



# Order Information

**LP-F35 3 2 1 0 1**

LP-F35	ADAPTOR TYPE		PANEL & SIZE		STYLE AND STRENGTH MEMBER		COLOR		PACKAGE QTY	
LANPRO SINGLE FIBER FUSION SPLICE PROTECTION SLEEVES	1	25 mm	0	1.0 mm for 250 µm	0	Steel Single Strength member	0	Clear	0	25 pieces
	2	40 mm	1	1.2 mm for 250 µm	1	Tapered ends Steel Single Strength member	1	Black	1	50 pieces
	3	45 mm	2	Micro 1.3 mm for 250 µm	2	FRP Single Strength member	2	Brown	2	100 pieces
	4	60 mm	3	1.5 mm for 250 µm	3	Tapered ends FRP Single Strength member	3	Red		
			4	Mini 1.6 mm for 250 µm	4	Ceramic (Dielectric) Single Strength member	4	Orange		
			5	Midi 1.9 mm for 900 or 250 µm	5	Ceramic (Dielectric) Dual Strength Member	5	Yellow		
			6	Standard 2.1 mm for 900 or 250 µm	6	Tapered ends Ceramic Single Strength member	6	Green		
			7	Standard 2.4 mm for 900 or 250 µm	7	Tapered ends Ceramic Dual Strength Member	7	Blue		
			8	US 2.6 mm for 900 or 250 µm	8	Pin Less Flexible	8	Purple		
			9	US Large 2.9 mm Large for 900 or 250 µm			9	Grey		
			A	Large 3.0 mm for 900 or 250 µm			A	White		
			B	Large 3.2 mm for 900 or 250 µm			B	Pink		
			C	Extra Large 3.7 mm for 900 or 250 µm			C	Turquoise		

**Example:**

LP-F3532101 Single Fiber Fusion Protection Sleeve, 45 mm length, 1.3 mm diameter tapered and Steel Single Strength Member, Clear Color, 25 per Package.

# Fiber Optic Splice Tray

The Fiber Optic splice trays provide the function of protection and storage of fiber splices, they allow fibers to be installed in a guided and orderly manner, with the proper radius of curvature.

## Specifications:

Capacity: 12 cores  
Material: High quality ABS white color plastic  
Dimensions: 154 x 91 x 10mm

## Applications:

Fiber Optic distribution frames (ODF)  
FTTH terminal box  
Fiber Optic splice closures  
Optical cabinets

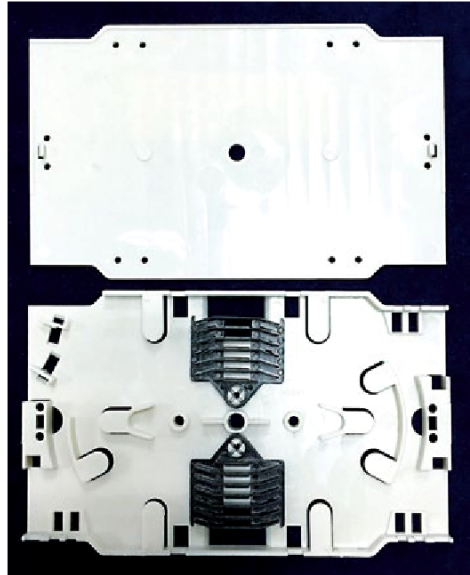

## Order Information

Part number	Description
LP-F701C1WH	White color ABS plastic Fiber Optic Splice tray for 12 cores with Shrink tube Fusion splices

# Fan-Out Kits for Indoor use

## Specifications:

- Length 36 inches.
- Eliminates strain on fibres by isolating them from tensile forces.
- Bend radius is limited by the tubing.
- Snap together furcation enclosure, eliminates epoxy filler adhesive for indoor kits, black colored.
- Compact design.
- Fiber routing capabilities are excellent for better fiber management.
- Are quick and easy to install.
- Wide temperature compensation.
- Optimized for indoor field termination of cables.
- Temperature range of 0° to +70°C (+32° to +158°F).

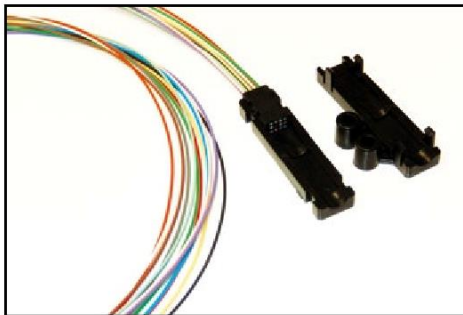

## Applications:

LanPro Indoor Fan-Out Kits provide our customers with the best practical solution for the field installation of connectors for terminating 6 and 12 fiber buffer tubes.

They are designed to sleeve the 250µm loose tube fibre with a 900 µm buffer tube. They are ideal for indoor cross connects and require no additional space or hardware devices for terminating buffer tubes.

The robust 900 µm fan-out has been color coded in order to facilitate the identification and matching with the individually colored fiber coming from the tube.

There are versions of 6 and 12 fibers and lengths of 25, 36 and 47 inches for your convenience and flexibility needed by your field installation.

Indoor kits are recommended in environments within a temperature range of 0° to +70°C (+32° to +158°F). In applications where colder temperatures are expected, the outdoor version is recommended.



## Order Information

Part number	Description
LP-F2101136121BK	Type 1 Fan-Out Kit for Flat Ribbon Fiber Cable with 12 Cores and 36 inch long LSZH rated 0.9 mm buffer tube colored legs, in a black color Enclosure for Indoor use.
LP-F2102136121BK	Type 2 Fan-Out Kit for Round 3mm Ribbon cable, or Loose Fibers in Round 3mm tubes with 12 Cores and 36 inch long LSZH rated 0.9 mm buffer tube colored legs in a black color Enclosure for Indoor use.
LP-F2103136121BK	Type 3 Fan-Out Kit for Round Tube Fiber Cable with 12 Cores and 36 inch long LSZH rated 0.9 mm buffer tube colored legs, in a black color Enclosure for Indoor use.

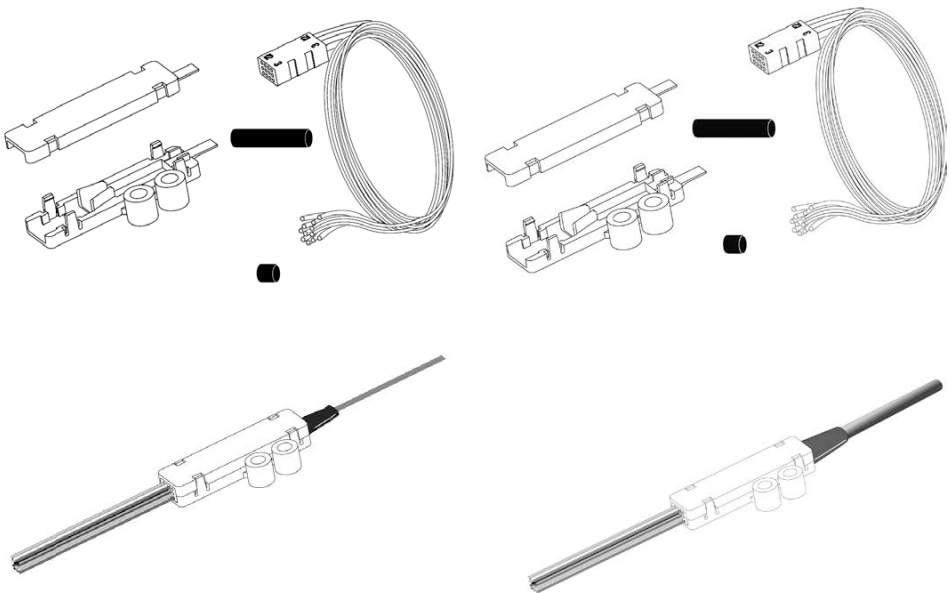

**\* Can be supplied under customer request.**

# How to select the proper type of Optical Fiber?

**What type of optical fiber should I use, singlemode (SM) or multimode (MM)? Which multimode fiber optic cable is the best option?**

There are two types of basic fibers:

**Singlemode (SM) (two types: OS1 and OS2)**

**Multimode (MM) (four types: OM1, OM2, OM3, and OM4)**

There also are several dozens of jackets, such as polyethylene, PVC, LSZH, silicone, among others. Similarly, the jackets can be armored to prevent rodent attacks; they can have more than one jacket and more than one cladding. These combinations are practically unlimited!

**THERE IS EVEN MORE TO FIBER THAN MEETS THE EYE!**

## Singlemode (SM)

---

This type of optical fiber is relatively simple and is smaller in diameter than the traditional fibers. SM fiber is made with a core of glass of 9  $\mu\text{m}$  and a cladding of 125  $\mu\text{m}$ . Transmission is possible by only one ray of light. SM fiber has an outer yellow jacket (PVC or LSZH) and it can be used for 100 km connections. Some people refer to singlemode optical fiber (SM) as OS1 and OS2. This is due to the attenuation of the SM thread, which depends on the cable construction and other manufacturing details.

Fundamentally:

- **OS1 “Optical Singlemode type 1”:** Este cable es hecho con la fibra G.652. La atenuación máxima a 1300 o 1500 nm es 1 dB/km.
- **OS2 “Optical Singlemode type 2”:** This cable is constructed with fiber G.652c. This type has maximum attenuation of 0.4 dB/km and it must have loose fibers inside the tube in order to reach such low levels of attenuation. OS2 also has a low water peak and it is useful for Metropolitan CWDM applications in a wide range of wavelengths.

As you can notice, OS1 and OS2 are singlemode (SM) and both of them have the same diameter. Thus, they use the same connectors and components, but 2 km of singlemode (SM) OS2 have lower attenuation than 1 Km of singlemode (SM) OS1. In case you need to deploy 100 km of fiber, OS2 will make your life easier!

## Multimode (MM)

Multimode optical fiber (MM) transmits several rays of light (modes) simultaneously. There are four basic types: Cores of 62.5  $\mu\text{m}$  (OM1) or 50  $\mu\text{m}$  (OM2, OM3, and OM4). Nowadays it is not enough to buy MM optical fiber: A LanPro client should not request generic multimode fiber; he needs to be more specific and ask for OM1, OM2, OM3, or OM4 since all these types are MM.

### There are four (4) basic types of multimode optical fiber (MM):

- **OM1** (optical mode 1): Original multimode fiber (MM) and rarely used nowadays. It has the largest diametrical core: 62.5  $\mu\text{m}$ . It works for 100 m and 1 G, however; it is limited for the current high demands of speed. OM1 is typically orange; we do not recommend it for new installations since it is not beneficial as 50  $\mu\text{m}$  fibers. In addition, it is more expensive than OM2!

- **OM2** (very popular nowadays): It is a good combination of performance and price. OM2 has a core diameter of 50  $\mu\text{m}$  and it was introduced in the 80s with 1 gb technology which was being tested at that time, but it is irrelevant now due to the development of

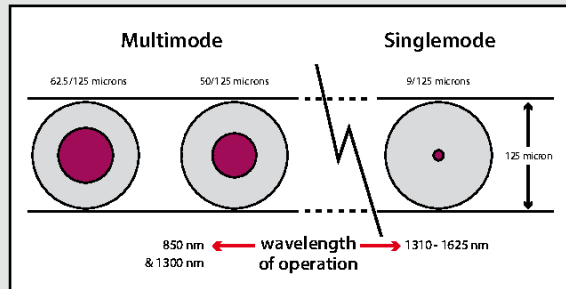

laser optimized multimode fibers. OM2 is not recommended for long distances.

- **OM3** It is also one of the most popular fibers nowadays. It has a glass diameter of 50  $\mu\text{m}$  and it is laser optimized. OM3 has been designed to work on the range of 40 G to 100 m and it is identified by its aquamarine color.

- **OM4** It is "The New Kid on the Block" and very expensive. Although it is available since many years, OM4 has just been standardized. It is also laser optimized and has a glass core of 50  $\mu\text{m}$ . This technology is the favorite for the emerging standards that will work in 40 G and in 10 G if distances are less than 150 m. OM4 is broadly used in data centers. It is suggested as a benchmark for the future.

	62.5/125 OM1	50/125 OM2	50/125 OM3	50/125 OM4	9/125 OS1
f/λ	200 MHz	500 MHz 850 nm	1500 MHz 850 nm	3500 MHz 850 nm	1310 nm
100 M	2 km	2 km	2 km	2 km	100 km
1 G	275 m	550 m	800 m	1100 m	100 km
10 G	33 m	82 m	300 m	550 m	40 km
40 G/100 G	N/A	N/A	100 m	150 m	40 km

## Practical examples from the previous chart:

Let's say our client needs a connection between 10 km and... He will obviously choose the singlemode optical fiber (SM) OS1, ideal for this scenario.

### Another example:

Your client needs a connection between two buildings with a distance of 100 m (328 ft). In this case OM3 will be the option, since 10 gb is just around the corner and OM2 does not cover more than 80 m. Likewise, OM3 will be able to manage 40 G at such distance.

**One more try:** Your client requires a 500 m connection (1640 ft). What would you select? OM4 for sure! This will let you reach 10 G, which is a tendency in the next ten years.

Fiber is not like its cousin, the copper wire. Fiber has more variables and details to be considered when selected. You can choose more than one type of fiber for the same scenario, thus the integrator should work at the desire speed, distance, attenuation, installation lifetime, and price of the active components as parameters to be considered when you select a type of fiber for a system. Consider the following aspects before selecting the fiber:

Distance	Unquestionably, singlemode reaches 100 G at 40 km
Speed	Singlemode can provide 40 G as OM4
Safety	No difference. Fiber optic cable is highly safe
Cable price	Small difference, although singlemode is cheaper
Ending	Singlemode has a core of smaller diameter and the ending is slower to do, which is time consuming
Active devices	Prices can be four times higher than multimode optical fiber (this is the biggest downside of singlemode)

To summarize, multimode (MM), types OM2, OM3, and OM4, is usually used for LANs and connections inside and between buildings with distances up to 550 m. In spite of the high price of the equipment, singlemode (SM) is the only alternative for networks based in MAN long distances. However, it is important to note that there will be a tendency to reduce the prices of singlemode equipment (SM), making it more feasible for short connections. For instance, some of our clients use singlemode (SM) for most of their projects no matter the distance, either short or long.

**LanPro** offers a complete array of fiber products available for immediate delivery for your applications, from OMI to OM4 and SM. In addition, we have a proper inventory of cables for indoor and outdoor environments for the most common applications. We also have expertise in manufacturing custom-made cables and OEM fibers, special jackets, FTTH styles, hybrids, OEM, mixtures, and many other products.

**LanPro is a US-based company with several decades of expertise that offers solutions for data transmission, either by air (wireless) or copper wire (LAN), and solutions based on light (fiber optics). For further information, do not hesitate to contact us.**

# • FIBER BLOWING MACHINES

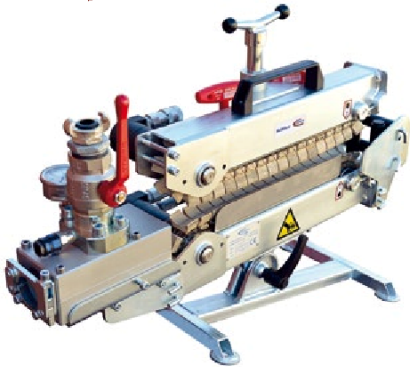

Model	MicroFlow Touch	MiniFlow Rapid	PowerFlow	MultiFlow
<b>Typical Usage</b>	Inside Plant	In/Outside Plant	Outside Plant	Outside Plant
<b>Fiber/Cable Diameter</b>	0,8 - 5,5 mm	4 - 12 mm	8 - 25 mm	8 - 32 mm
<b>Tube Size (OD)</b>	5 - 16 mm	7 - 20 mm	18 - 70 mm	18 - 70 mm
<b>Part #</b>	101 - 10005	101 - 10031	101 - 10001	101 - 10002
<b>Install Speed to</b>	90 m/min	100 m/min	80 m/min	80 m/min
<b>Distance</b>	Up to 2.5 km	Up to 3.5 km	Up to 10 Km	Up to 10 Km
<b>Recommended Airflow</b>	200 - 500 l/pr. min	1000 l/pr. min	8000 - 12000 l/pr.min	8000 - 12000 l/pr.min
<b>Recommended Pressure</b>	8 - 16 bar air	8 - 16 bar air	8 - 16 bar air	8 - 12 bar air
	<b>Machine:</b>	<b>Control Box:</b>		
<b>Length:</b>	25 cm	25 cm	650 mm	700 mm
<b>Width:</b>	15 cm	16 cm	225 mm	230 mm
<b>Height:</b>	22 cm	13 cm	210 mm	350 mm
<b>Weight:</b>	9,7 kg	1,9 kg	24 kg	40 kg
<b>Unique Features</b>	Automatic Buckle Detection Adjustable Torque Preset Automatic Stop Adjustable Speed Control Speed, Torque & Count Display Air Pressure & Flow Regulation Easy to Operate Simple Maintenance	Use with Air or Water Push Force Monitor Rugged Construction Flexible Adaptability Adjustable Torque Distance and Speed measurement Ease of Use Simple Maintenance	Use with Air or Water Installs Single Cable Rugged Construction Flexible Adaptability Adjustable Torque Distance and Speed measurement Ease of Use Simple Maintenance	Use with Air Water Jets Tubes or Cable Rugged Construction Flexible Adaptability Adjustable Torque Distance and Speed measurement Ease of Use Simple Maintenance



# Fiber Blowing Machine



**SLANPRO**

## Specifications:

### ● User friendly desing

MINIFLOW RAPID has a user friendly design, that makes for easy operation. The machine is designed with the main focus on functionality that includes:

- Rugged Stainless construction
- Safety chain guard
- Large easy to use adjustable knobs
- Push force indicator.

● **Efficient cable blowing** Compact and efficient cable blowing machine. The machine is capable of installing fiber cable at a speeds up to 100m/min. and yo ti a dustabce if 3.5 km.

● **Built-in meter counter and tachometer** Has a built-in digital meter counter and tachometer with long life battery (7 years).

● **Robust and compact** The machine is constructed in stainless steel and anodized aluminium that makes it suited for use under rugged conditions at cable blowing locations.

● **Flexible** The machine can quickly be adapted to accommodate different cable and duct sizes.

- Micro cable diameter: 4 - 12 mm.
- Micro duct diameter: 7 - 20 mm.
- Blowing distance<sup>1</sup>: Up to 3,5 km.
- Blowing speed: Up to 100 m/min.
- Recommended pressure and airflow<sup>2</sup>: 8-16 bar (100 l/pr.min)
- Weight: 24 kg
- Length: 650 mm
- Width: 225 mm
- Height: 210 mm

<sup>1</sup>Depending on type of micro duct and cable.

<sup>2</sup>Cooled and dried air.



## CABLE DAMAGE SAFETY

MINIFLOW RAPID has a unique monitoring system, which continuously monitors the pushing force, applied on the fiber cable. This makes it possible to stop the drive wheels before the cable is damaged.

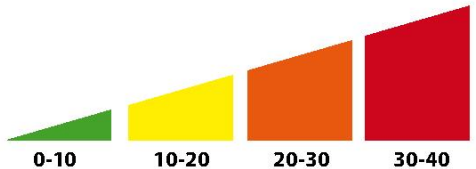

# HDPE Tube Bundle DB Series

## Specifications:

### Individual Microduct:

- Microduct  $\Phi 14/12$  mm
- Outer diameter (mm):  $14.0 \pm 0.1$
- Wall thickness (mm):  $1.0 \pm 0.1$
- Ovality (% , before coiled):  $\leq 5$
- Max. Pulling force (N): 550

### Tube bundle:

- Weight: 746 Kg/k m
- Bending radius: 600 mm
- Tensile strength: 7340 N
- Internal pressure: 12 bar
- Crush performance: 2000 N
- Outdoor exposure limit: 6 Month
- Maximum delivery lengths on drums: 1000 m

### Standard:

- Crush performance: IEC 60794-1-2-E3
- Tensile: IEC 60794-1-2-E1
- Bend: IEC 60794-1-2-E11
- Flexibility: IEC 60794-1-2-E8

### Storage:

- Completed packages of the HDPE Tube Bundle on drums can be stored outdoor max. 6 months upon the date of production.
- Storage temperature:  $-40^{\circ}\text{C} \sim +70^{\circ}\text{C}$
- Installation temperature:  $-20^{\circ}\text{C} \sim +50^{\circ}\text{C}$
- Operating temperature:  $-40^{\circ}\text{C} \sim +70^{\circ}\text{C}$

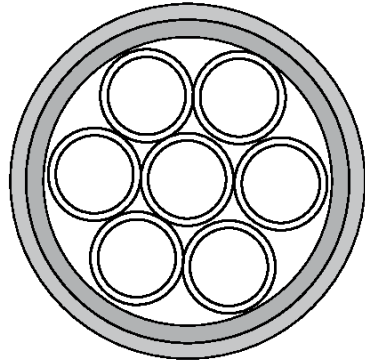

## Applications

Developed to be the best solution of direct burial modular-tubes family, featuring a non-metallic construction.

A bundle of micro- or mini-tubes (regular wall size) is surrounded by dual HDPE sheath. The design makes the duct assemblies suitable for outdoor direct buried. The microducts are optimized for best cable blowing performance.

# HDPE Tube Bundle DB Series

## Specifications:

### Inner micro duct

- Microduct  $\text{Ø}12/10\text{mm}$
- Outer diameter (mm):  $12.0 \pm 0.1$
- Wall thickness (mm):  $1.0 \pm 0.1$
- Ovality (% , before coiled):  $\leq 5$
- Max. Pulling force (N): 575

### Tube bundle:

- Tensile strength: 4600 N
- Bending radius: 580 mm
- Crush performance: 2000 N
- Impact: 12 J
- Internal pressure: 12 bar

### Storage:

- Completed packages of tube bundle on drums can be stored outdoor max. 12 months upon the date of production.
- Storage temperature:  $-40^{\circ}\text{C}$  to  $70^{\circ}\text{C}$
- Installation temperature:  $-20^{\circ}\text{C}$  to  $50^{\circ}\text{C}$
- Operating temperature:  $-40^{\circ}\text{C}$  to  $70^{\circ}\text{C}$

## Applications

Developed to be the best solution of direct burial modular-tubes family, featuring a non-metallic construction.

A bundle of micro- or mini- tubes (regular wall size) is surrounded by dual HDPE sheath. The design makes the duct assemblies suitable for outdoor direct buried. The microducts are optimized for best cable blowing performance.

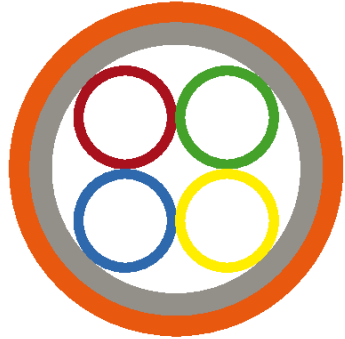

# HDPE Tube Bundle DB Series

## Specifications:

### Individual Microduct:

- Microduct  $\Phi$ 12/10mm
- Outer diameter (mm):  $12.0 \pm 0.1$
- Wall thickness (mm):  $1.0 \pm 0.1$
- Ovality (%), before coiled:  $\leq 5$
- Max. Pulling force (N): 515

### Tube bundle:

- Weight: 306 Kg/km
- Bending radius: 300 mm
- Tensile strength: 3000 N
- Internal pressure: 12 bar
- Crush performance: 2000 N
- Outdoor exposure limit: 6 Month
- Maximum delivery lengths on drums: 1000, 2000 m

### Standard:

- Crush performance: IEC 60794-1-2-E3
- Tensile: IEC 60794-1-2-E1
- Bend: IEC 60794-1-2-E11
- Flexibility IEC 60794-1-2-E11: IEC 60794-1-2-E11

### Storage:

Completed packages of the HDPE Tube Bundle on drums can be stored outdoor max. 6 months upon the date of production.

- Storage temperature:  $-40^{\circ}\text{C} \sim +70^{\circ}\text{C}$
- Installation temperature:  $-20^{\circ}\text{C} \sim +50^{\circ}\text{C}$
- Operating temperature:  $-40^{\circ}\text{C} \sim +70^{\circ}\text{C}$

## Applications

Developed to be the best solution of direct burial modular-tubes family, featuring a non-metallic construction.

A bundle of micro- or mini-tubes (regular wall size) is surrounded by dual HDPE sheath. The design makes the duct assemblies suitable for outdoor direct buried. The microducts are optimized for best cable blowing performance.

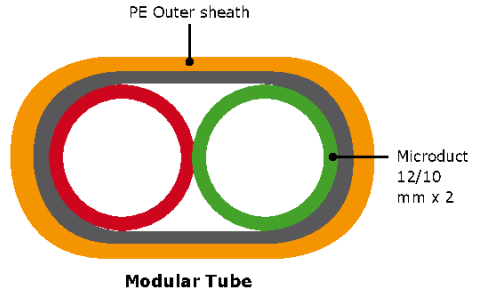

# HDPE Tube Bundle DB Series

## Specifications:

- Two layers, inner and outer layer is manufactured by the technology of synchronized extrusion of PE in order to achieve the tight joint without separation.
- Inner wall of duct has two kinds: smooth inner wall or the inner wall with longitudinal ribs to guide the airflow.
- No matter which kinds, both are permanently solid lubricant layer with very low friction of coefficient. The duct surface is smooth without defects such as visible holes or scars.
- Tensile Strength:  $\geq 20$  MPa
- Elongation Rate at break:  $\geq 350$  %
- Bending Test:  $\geq 12$  D
- Longitudinal Conversion Rate:  $\leq 3$  %
- Endurable Inner Pressure: 1.2 MPa
- Friction Coefficient of inner wall:  $\leq 0.1$

Micro duct refers to the duct made of high density polyethylene (HDPE) as raw material and made by PE co-extrusion technology. Its nominal out diameter is less than 16mm and its inner wall is permanent solid lubricant layer (silicon layer). Its inner wall has two kinds as below:

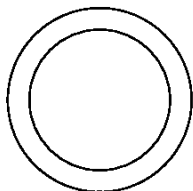

**Micro duct  
with smooth inner wall**

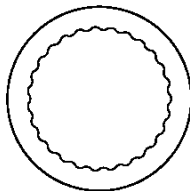

**Inner wall with  
longitudinal ribs to guide  
the airflow**



**SHD (super heavy duty)**



**HD (heavy duty)**



**Indoor**

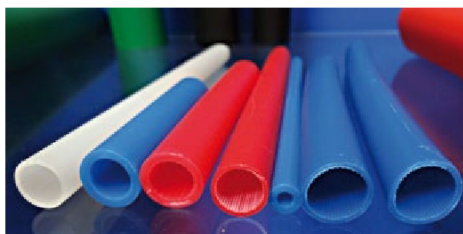

Type	Named Dimension mm OD×ID	OD Deviation mm	Wall Thickness Deviation mm
LPM0535	Φ5.0×3.5	-0.10, +0.10	-0.1, +0.1
LPM0735	Φ7.0×3.5	-0.10, +0.10	-0.1, +0.1
LPM0755	Φ7.0×5.5	-0.10, +0.10	-0.1, +0.1
LPM0806	Φ8.0×6.0	-0.10, +0.10	-0.1, +0.1
LPM1008	Φ10.0×8.0	-0.10, +0.10	-0.1, +0.1
LPM1210	Φ12.0×10.0	-0.10, +0.10	-0.1, +0.1
LPM1410	Φ14.0×10.0	-0.10, +0.10	-0.1, +0.1
LPM1412	Φ14.0×12.0	-0.10, +0.10	-0.1, +0.1
LPM1614	Φ16.0×14.0	-0.10, +0.10	-0.1, +0.1
LPM2016	Φ20.0×16.0	-0.10, +0.10	-0.1, +0.1

# • RELATED PRODUCTS

## Media Converters

The LanPro Fiber Media Converters operate as seamless bridges between 10/100/1000 UTP ports and optical ports. The IP data is immediately and flawlessly translated from one port to the other, both ways.

By using standard 850/1310/1550 nm wavelengths, singlemode or multimode fiber, single fiber and WDM technology or dual fiber schemes, the network coverage can be extended enormously from the UTP maximum of 100 m to up to 80 km in some cases. Single or Multimode fiber are used depending again on the fiber available or best suited for the application.

In example: where legacy multimode fiber is already installed and substitution is not feasible and migration to Gigabit is mandatory, LanPro's LP-ICF310005 Fiber Media Converter solve this application.

### Double Fiber Gigabit 10/100 Mbps Media Converter Series

- Double Fiber 10/100 Mbps Media Converter Series.
- Distance supported by Multimode: 550m or 2km and Singlemode: 20/40/60/80/120km.
- Standards compliance: IEEE802.3, IEEE802.3u 10/100Base-TX, 100Base-FX
- The Twisted pair port supports Auto-Negotiation for a automatic selection of speed and automatic crossover MDI/MDIX.
- Switching mode: Store and Forward.
- LED Indicators: PWR, TX-LNK, TX-ACT, FX-LNK, FX-ACT, FDX.
- Connector: FTP RJ45 and 2x SC.



### Double Fiber Gigabit 10/100/1000 Mbps Media Converter Series

- Double Fiber Gigabit Media Converter.  
Wavelength: 850nm for 550m, 1310nm from 2km to 20km and 1550nm from 40km to 60km.
- Gigabit 10/100/1000M Speeds.
- Transmission Distance: Multimode from 550m to 2km and Singlemode from 20km to 60km.
- 802.3z and 802.3ab standards compliant.
- The FTP port supports Auto-Negotiation for a fast automatic speed selection.
- Auto-MDI/MDIX support.
- LED Indications: PWR, TX-LNK, TX-ACT, FX-LNK, FX-ACT, FDX.
- Connector: one(1) FTP RJ45 and two(2) SC.



## WDM Bidirectional 10/100 Mbps Media Converter Series

- Singlemode/Multimode one fiber only.
- BiDi (bidirectional) technology, 1310nm/1550nm and 1550nm/1310nm, WDM 10/100M, Multimode distances of 550m and Singlemode distances of 2/20/25/40/60/80km. (Sold in Pairs or on side to be used).
- Complies IEEE802.3, IEEE802.3u 10/100Base-TX, 100Base-FX Standards.
- Connectors: (1)TP RJ45 and (1)SC.
- TP Port supports Auto-Negotiation for fast automatic speed selection.
- Auto MDI/MDIX.
- Store and Forward switching mode.
- LED indicators: PWR, TX-LNK, TX-ACT, FX-LNK, FX-ACT, FDX.



## WDM Bidirectional Gigabit 10/100/1000 Mbps Media Converter Series

- Individual Fiber Gigabit Media Converters.
- BiDi technology(bidirectional), 1310nm/1550nm and 1550nm/1310nm, WDM 10/100/100M, Multimode distances to 550m y Singlemode distances of 2/20/40/80km. (Sold in Pairs or on side to be used).
- Gigabit speeds 10/100/1000M.
- Complies 802.3z and 802.3ab standards.
- TP Port supports Auto-Negotiation for fast automatic speed selection.
- Auto MDI/MDIX.
- LED indicators: PWR, TX-LNK, TX-ACT, FX-LNK, FX-ACT, FDX.
- Connectors: (1)TP RJ45 and (1)SC..



LanPro offers a complete line of SFP transceivers (short form factor pluggable) E.G.: Copper, WDM (1 fiber) in 100M and Gigaspeed, Traditional (2 fibers) also in 100M and Gigaspeed, and also the new 10G for distances from 550m to 120km.

These transceivers are used in an ample range of applications like LAN's, WAN's, MAN's, High Capacity Storage (NAS), and other. Besides that, our modules can optionally provide the Digital Diagnostic Function.

All of our modules comply the RoHS norm and can be made 100% compatible with the following Brands: Cisco, Extreme, Juniper, HP, H3C, Linksys, Huawei, HTC, Alcatel-Lucent, Foundry, Nortel, Force10 etc.

## Transceiver SFP Copper, Duplex RJ45

- For up to 1.25Gb/s bidirectional data links.
- (Hot-pluggable) SFP template.
- Extended temperature range available (0°C a +85°C).
- In metallic enclosure for lower EMI noise.
- Low power (1.05 W typical).
- The RJ45 assembly is very compact.
- SERDES interface for 1000 BASE-T operation with Host.
- SGMII interface for 10/100/1000Mbps operation with Host
- Complies with interface transfer rates for Host type systems.



## Transceiver SFP Singlemode (SM) LC Duplex DDM, 1000BASE-EX

- For up to 1.25Gb/s bidirectional data links.
- FP Laser in 1310nm and PIN Photo Diode for up to 40 Km distance transmissions.
- Compliant with the SFP standard and with the SFF-8472 with duplex connector.
- Has Digital Diagnostic MoNITORING(ddm): with internal and external calibration.
- Compatible WITH SONET OC-24-LR-1.
- Compatible WITH RoHS.





## Transceiver SFP Singlemode (SM) LC Duplex MSA, 1000BASE-LX

- For up to 1.25Gb/s bidirectional data links.
- Fabry-Perot Transmitting Laser in 1310 nm.
- LC duplex Connector.
- Transmission distance up to 20km on 9/125  $\mu\text{m}$  fiber.
- IEEE Std 802.31 Gigabit Ethernet standard compliant for 1x fiber channel.
- Typical low power dissipation of less than 700mW.



## Transceiver SFP Multimode (MM) LC Duplex MSA, 1000BASE-SX

- For up to 1.25Gb/s bidirectional data links.
- VCSEL type Transmitting Laser on 850nm.
- Transmitting distance up to 550m on 50/125  $\mu\text{m}$  and up to 220 m on 62.5  $\mu\text{m}$  multimode fiber.
- Typical low power dissipation of less than 700mW
- IEEE Std 802.31 Gigabit Ethernet standard compliant for 1x fiber channel.



## Transceiver SFP Singlemode (SM) LC Duplex MSA, 1000BASE-ZX

- For up to 1.25Gb/s bidirectional data links.
- Transmitting distance up to 80km. (Hot-pluggable) SFP template
- DFB Laser and PIN Diode on 1550 nm.
- I/O Data Interface with LVPECL.
- Low EMI and excellent ESD.
- IEC-60825 RoHS Laser standard compliant.



## Transceiver SFP Multimode (MM) MSA, LC Duplex, 1000BASE-ZX

- For up to 1.25Gb/s bidirectional data links.
- Transmission distance up to 550m
- (Hot-pluggable) SFP template.
- DFB Laser and PIN Diode on 1550 nm.
- Data input/output interface with LVPECL.
- Low EMI and excellent ESD protection.
- IEC-60825 RoHS Laser standard compliant
- Compatible with RoHS.



## Transceiver SFP Singlemode (SM) DDM, LC Duplex, 1000BASE-ZX

- For up to 1.25Gb/s bidirectional data links.
- DFB Laser and PIN Diode on 1550 nm.
- Has Digital Diagnostic MoNITORING(DDM): with internal and external calibration.
- Low EMI and excellent ESD protection.
- IEC-60825 RoHS Laser standard compliant
- Compatible with RoHS.



## Transceiver SFP Multimode (MM) DDM, LC Duplex, 1000BASE-ZX

- For up to 1.25Gb/s bidirectional data links.
- DFB Laser and PIN Diode on 1550 nm.
- Has Digital Diagnostic MoNITORING(DDM): with internal and external calibration.
- Transmitting distance up to 550m on multimode fiber.
- Low EMI and excellent ESD protection.
- IEC-60825 RoHS Laser standard compliant
- Compatible with RoHS.

## Transceiver SFP Multimode (OM1) MSA, LC Duplex, 10GBASE-LRM

- Transmission rate 9.95 to 10.3Gbps
- Transmitting distance up to 220m Huella SFP+
- (Hot-pluggable) SFP template.
- Fabry-Perot Transmitting Laser in 1310 nm, PIN Photo Diode.
- Has Digital Diagnostic Monitoring(DDM).
- Compatible WITH RoHS, Lead free.
- In metallic enclosure for lower EMI noise.
- Single 3.3V power supply.
- FC-P1-4 800-Mx-SN-I, SFF-8431, SFF-8432, and SFF-8472 standard compliant.



## Transceiver SFP Multimode (MM) DDM, LC Duplex, 2GBASE

- For up to 2.67Gbps bidirectional data links.
- VCSEL type Transmitting Laser on 850nm.
- Transmitting distance up to 300m.
- SFP MSA , SFF-8472 standards compliant.
- Has Digital Diagnostic Monitoring(DDM): with internal and external calibration.
- Compatible with RoHS.



**LANPRO**  
*Connect-and-Forget*

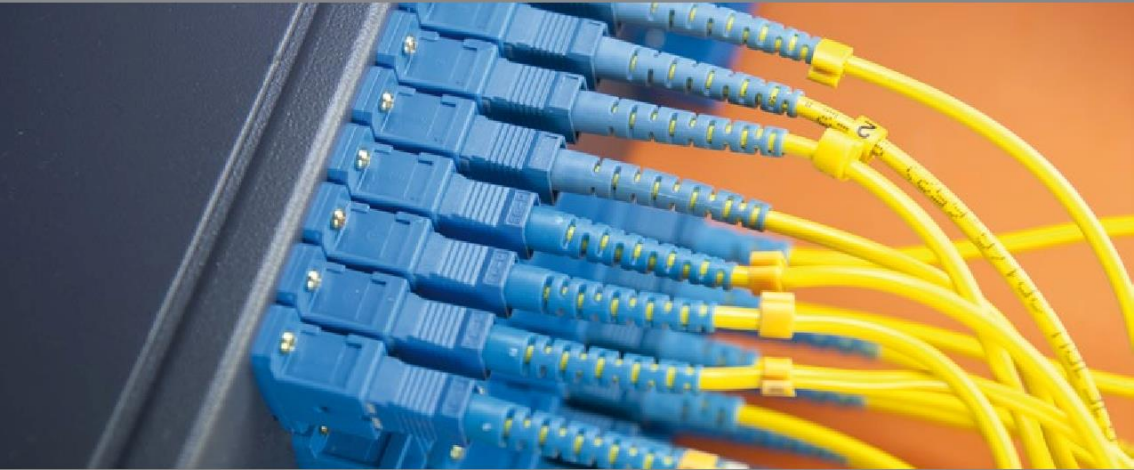

# **LANPRO**

## **Fiber Solutions Catalog**

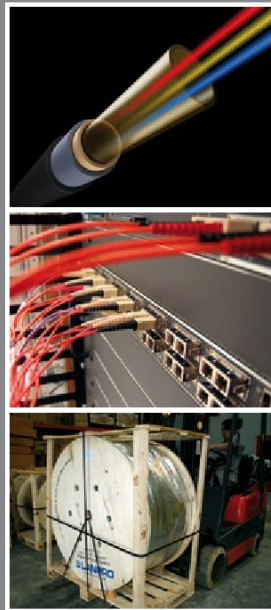



Pasaje José Melo N43-26 y Tomás de Berlanga.  
Quito / Ecuador



+593 2 264602 / 4604

**LANPRO**  
*Connect-and-Forget*

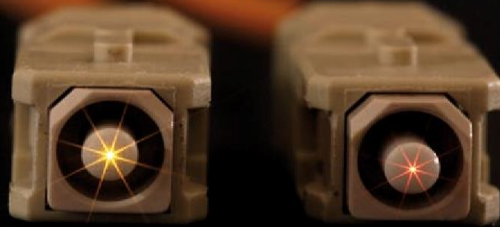

Designed and Manufactured under LanPro™ standards and specifications.  
LanPro™ is a member of One Network Alliance Group of Companies.  
LanPro™, Connect-and-Forget™ and LanProfessional are US registered brands.  
LanPro Networks Inc: 1880 NW 93rd Av, Doral, Florida 33172, USA.  
Main web page: [www.lanpro.com](http://www.lanpro.com) Support: [support@lanpro.com](mailto:support@lanpro.com)